

VISTA DAL BASSO  
BOTTOM VIEW  
VUE CI-DESSOUS  
VISTA DESDE ABAJO  
BLICK VON UNTEN

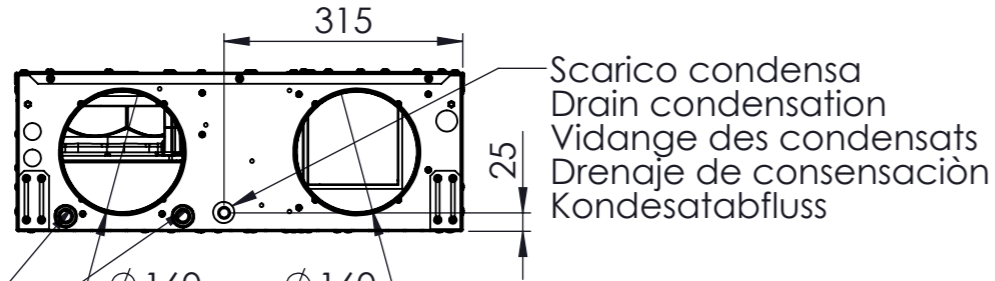

Scarico condensa  
Drain condensation  
Vidange des condensats  
Drenaje de condensación  
Kondensatabfluss

Ingresso secondario alimentazione elettrica  
Secondary power supply input  
Entrée d'alimentation secondaire  
Entrada de fuente de alimentación secundaria  
Sekundäre Stromversorgungseingang

Fori di fissaggio per installazione a parete  
Fixing holes for wall installation  
Trous de fixation pour l'installation murale  
Orificios de fijación para instalación en pared  
Befestigungslöcher für die Wandmontage

Pannello accesso ionizzatore (opzionale)  
Ionizer access panel (optional)  
Panneau d'accès ioniseur (en option)  
Panel de acceso al ionizador (opcional)  
Ionizer Access Panel (optional)

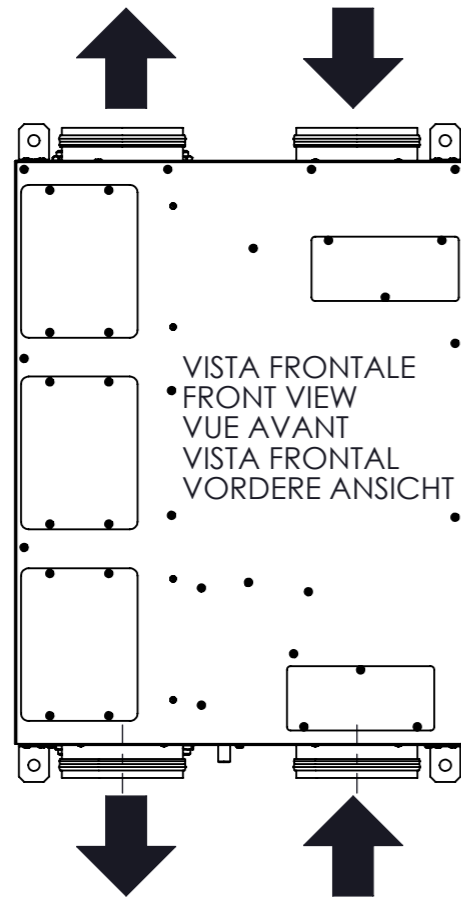
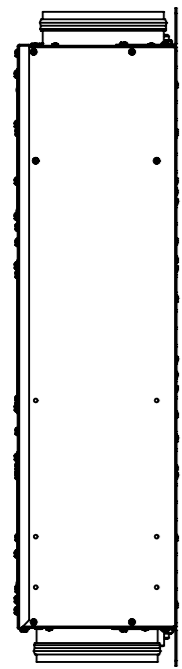

VISTA FRONTALE  
FRONT VIEW  
VUE AVANT  
VISTA FRONTAL  
VORDERE ANSICHT

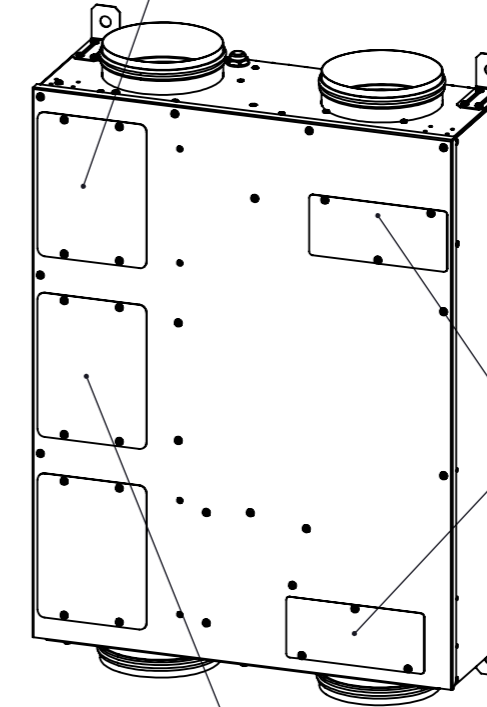
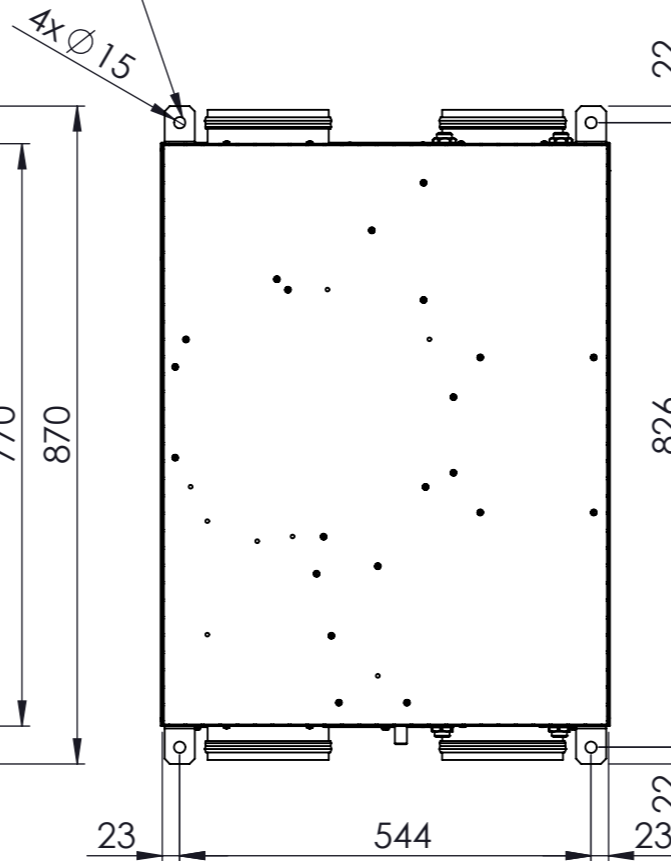
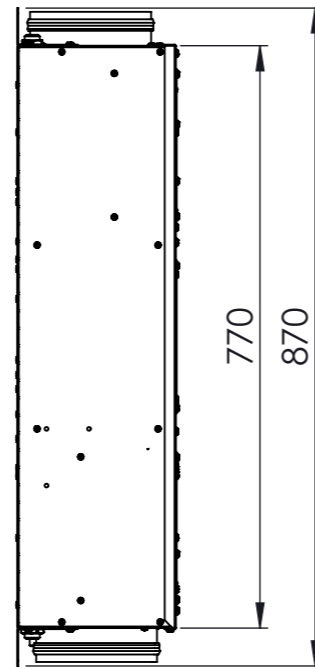

Accesso filtri aria  
Air filters acces  
Accès aux filtres à air  
Acceso a filtros de aire  
Zugang zu Luftfiltern

Quadro elettrico  
Electrical panel  
Armoire électrique  
Panel electrico  
Schalttafel

Ingresso connessioni elettriche  
Electrical connection input  
Entrée de connexion électrique  
Entrada de suministro de energia  
Elektrischer Verbindungseingang

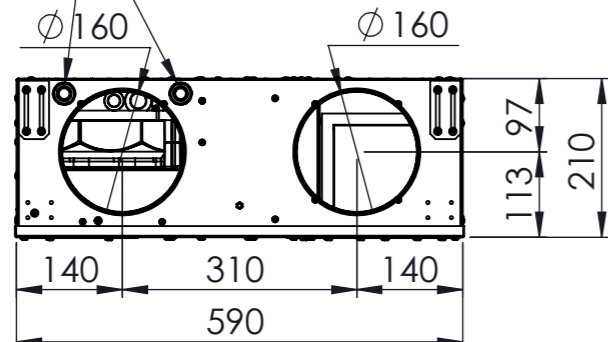

VISTA DALL'ALTO  
TOP VIEW  
VUE DE DESSUS  
VISTA SUPERIOR  
DRAUFSICHT

	Data/e - Visto/Ckd	Rev.	Descrizione modifiche - Modification description	
	Data/e - Visto/Ckd	Rev.	Descrizione modifiche - Modification description	
	Data/e - Visto/Ckd	Rev.	Descrizione modifiche - Modification description	
Data - Date	31/03/2021		Autore tavola - 2D drawing designer	Autore modello - 3D model designer
			M. Peraro	M. Peraro
Descrizione - Description Disegno dimensionale - Dimensional draw - Dessin dimensionnel - Dibujo dimensional - Maßzeichnung RCE 016			Serie - Series RCE	Materiale - Material -
			Modello - Model 016	QUOTE SENZA INDICAZIONE DI TOLLERANZA GRADO DI PRECISIONE MEDIO - UNI 5307-63
Codice/Disegno - Code/Drawing			Peso - Weight (kg)	Rev. / Visto - Checked
-			/	/