

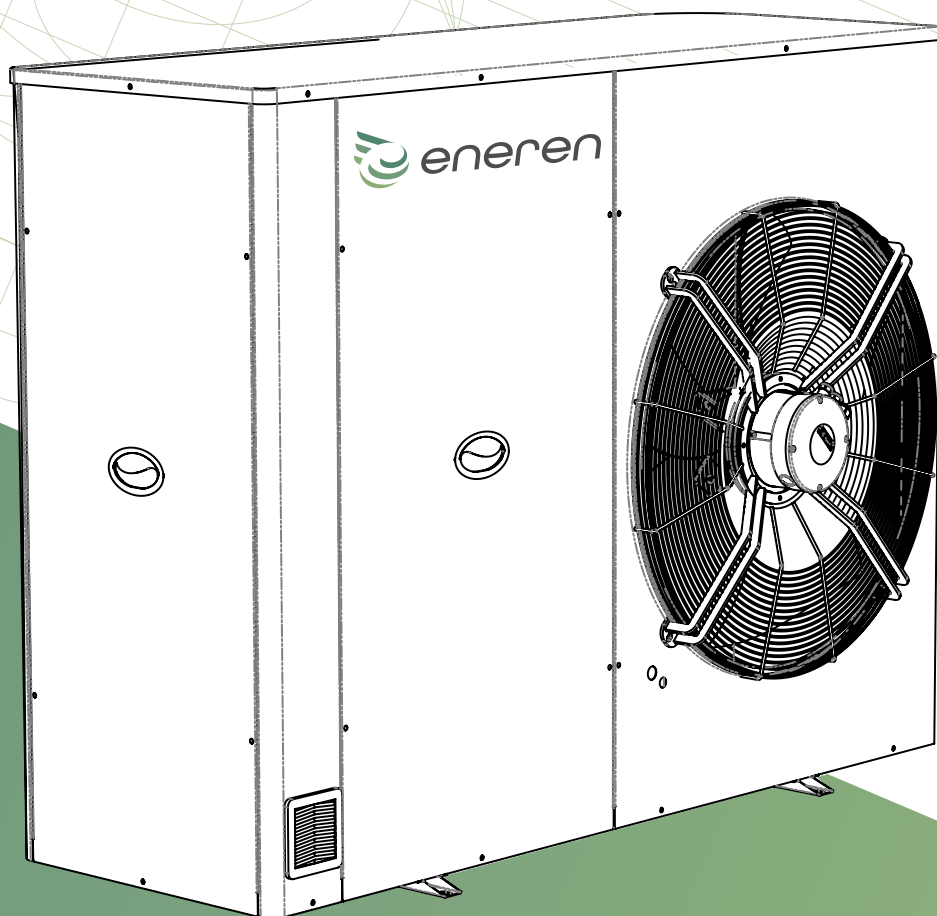

USER MANUAL AND TECHNICAL MANUAL

# ETH

MULTISOURCE AIR-WATER / WATER-WATER HEAT PUMP



**EN**  
**TRANSLATION OF THE ORIGINAL INSTRUCTIONS**

HF61GJ0397B / 11\_22



## INTRODUCTION

### ETH

#### MULTISOURCE AIR/WATER and WATER/WATER UNIT

##### **WARNING**

**CAREFULLY READ THIS MANUAL BEFORE USING THE UNIT.**

##### **DECLARATION OF CONFORMITY**

**The declaration of conformity is attached separately to the documents on board the unit, usually placed inside the electrical compartment.**

Dear Customer,

whilst thanking you for having chosen a product of ours, we are pleased to provide this manual for optimal use of our product for better work results.

Please read the recommendations described in the following pages carefully and keep the manual available to personnel who will be responsible for managing and maintaining the unit.

Our company is at your complete disposal for any and all questions that you should require both in the unit starting phase and at any time of its utilization.

Should scheduled and unscheduled maintenance be necessary, please contact our After-sales Technical Service for assistance and spare parts.

Please find our contact details below for a more rapid service:



ENEREN S.r.l.  
Viale Spagna, 31/33  
35020 Tribano (Pd) ITALY  
Tel + 39 049 9271513  
Fax + 39 049 9588522  
e-mail : info@eneren.it



**049-9271513**



**support@eneren.it**

## START-UP INSTRUCTIONS

### 1 YOUR INSTALLATION

All the tips required for a perfect installation of the equipment can be found in the installation manual. It is important to place a net filter at all water circuit inlets.

The filter must be made of stainless steel with a mesh that does not exceed 1 mm.

### 2 REQUIRED ACCESSORIES FOR A PROPER INSTALLATION OF THE UNIT

For the proper operation of the unit and for the validity of the warranty, the installation of the following hydraulic components will be necessary:

- Y-strainers in the inlet pipes to the unit;
- anti-vibration couplings in each pipe connected to the unit;
- appropriately dimensioned safety valves on each circuit of the system;
- appropriately dimensioned expansion vessels on each circuit of the system.

### 3 FIRST START-UP

With at least 15 working days in advance, send the machine start request via email or fax to the following contact ENEREN:

**Fax.** 049 9588522

**e-mail:** support@eneren.it

**Tel.** 049 9271513

ENEREN Assistance will organize the intervention by putting you in contact with Authorized Technical Assistance Center of the area.

All the preliminary checks and testing of the machine will be carried out together with your staff.

Your staff will be given instructions for the correct running of the machine.

### 4 WARRANTY ISSUE

For the warranty to be valid, the first start-up by an Authorized Technical Assistance Center is mandatory

After testing, the Authorized Technical Assistance Center will issue a valid test certificate for the machine warranty.

### 5 CONNECTIONS

Here below are the minimum diameters for the pipes providing the connection to the units.

These diameters must be verified on the basis of the useful heads of the circulation pumps declared in the dedicated paragraph of the following manual.

ETH	size	006	008	010	015	017
Minimum diameter of the connection pipes	inches		1"		1" ½	

## TABLE OF CONTENTS

<b>1</b>	<b>INTRODUCTION</b> .....	<b>p. 3</b>	<b>9</b>	<b>ELECTRICAL CONNECTIONS</b> .....	<b>p. 33</b>
<b>2</b>	<b>START-UP INSTRUCTIONS</b> .....	<b>p. 4</b>	9.1	GENERAL DESCRIPTION .....	p. 33
	<b>USER MANUAL</b> .....	<b>p. 6</b>	9.2	EXTERNAL ENABLING CONTROLS .....	p. 33
<b>3</b>	<b>GENERAL DESCRIPTION</b> .....	<b>p. 7</b>	9.3	REMOTE SUMMER-WINTER SWITCHING .....	p. 33
3.1	PRECAUTIONS FOR USE .....	p. 7	<b>10</b>	<b>START-UP</b> .....	<b>p. 35</b>
3.2	PREAMBLE .....	p. 7	10.1	PRELIMINARY CHECKS .....	p. 35
3.3	LIABILITY .....	p. 7	10.2	START-UP THE UNIT .....	p. 35
3.4	INTENDED USE .....	p. 8	10.3	SELECTING THE OPERATING MODES .....	p. 36
3.5	IDENTIFICATION OF THE UNIT .....	p. 8	10.4	SETTING THE SET-POINTS .....	p. 37
3.6	GENERAL INSTRUCTIONS .....	p. 8	10.5	CHECKS DURING OPERATION .....	p. 37
<b>4</b>	<b>SAFETY INSTRUCTIONS</b> .....	<b>p. 10</b>	10.6	STOPPING THE UNIT .....	p. 38
4.1	GENERAL CAUTIONARY NOTES .....	p. 10	<b>11</b>	<b>ROUTINE MAINTENANCE AND CHECKS</b> ..	<b>p. 39</b>
4.2	SAFETY PRESCRIPTIONS .....	p. 11	11.1	WARNINGS .....	p. 39
<b>5</b>	<b>DESCRIPTION OF THE PRODUCT AND TECHNICAL DATA</b> .....	<b>p. 14</b>	11.2	MAINTENANCE TABLE .....	p. 39
5.1	MAIN COMPONENTS .....	p. 14	11.3	REFRIGERATION CIRCUIT REPAIRS .....	p. 40
5.2	OPERATING LIMITS .....	p. 14	11.4	TIGHTNESS TEST .....	p. 40
5.3	CHARACTERISTIC CURVES OF THE CIRCULATION PUMPS (CONFIGURATOR FIELD 3 AND 4) .....	p. 17	11.5	HIGH VACUUM AND REFRIGERATION CIRCUIT DRYING .....	p. 40
5.4	CALIBRATION OF CONTROL DEVICES .....	p. 20	<b>12</b>	<b>TROUBLESHOOTING</b> .....	<b>p. 41</b>
5.5	SYSTEM BOOKLET .....	p. 21	12.1	UNIT ALARM .....	p. 41
<b>6</b>	<b>INSPECTION AND TRANSPORT</b> .....	<b>p. 22</b>	12.2	TROUBLESHOOTING .....	p. 41
6.1	INSPECTION .....	p. 22	<b>13</b>	<b>SAFETY DATA SHEET OF REFRIGERANT</b> .....	<b>p. 42</b>
6.2	LOCATION OF SAFETY DATA PLATES .....	p. 22	<b>14</b>	<b>MAINTENANCE TABLE</b> .....	<b>p. 43</b>
6.3	RESIDUAL RISK AREAS .....	p. 23	<b>15</b>	<b>SYSTEM DIAGRAMS</b> .....	<b>p. 44</b>
6.4	LIFTING AND CONVEYANCE .....	p. 24	<b>16</b>	<b>NOTES</b> .....	<b>p. 46</b>
6.5	UNPACKING .....	p. 24			
<b>7</b>	<b>RETIRING THE UNIT</b> .....	<b>p. 25</b>			
7.1	ENVIRONMENT PROTECTION .....	p. 25			
7.2	WASTE ELECTRICAL AND ELECTRONIC EQUIPMENT MANAGEMENT .....	p. 25			
7.3	PACKAGING DISPOSAL .....	p. 26			
	<b>TECHNICAL MANUAL</b> .....	<b>p. 27</b>			
<b>8</b>	<b>INSTALLATION</b> .....	<b>p. 28</b>			
8.1	POSITIONING AND INSTALLATION .....	p. 28			
8.2	QUALITY OF THE WATER IN THE SYSTEMS .....	p. 28			
8.3	GENERAL GUIDELINES FOR PLUMBING CONNECTIONS .....	p. 29			
8.4	BUFFER TANK FOR HEATING AND COOLING CIRCUIT .....	p. 29			
8.5	CONTROL AND SAFETY DEVICES .....	p. 30			

**USER MANUAL**

## 3 GENERAL DESCRIPTION

### 3.1 Precautions for use



The operating rules contained in this manual are solely applicable for the units:

#### ETH

The instructions manual must be read and used as follows:

- every unit operator and maintenance technician must carefully read the entire manual and comply with that stipulated therein;
- the employer must ensure that the operator has the requirements to operate the unit and has carefully read the manual;
- read the instructions manual carefully and consider it an integral part of the unit;
- the instructions manual must be readily available to operating personnel and maintenance technicians;
- keep the manual throughout the life of the unit;
- make sure that any update is included in the text;
- hand the manual to any other user or subsequent owner of the unit;
- use the manual in such a way so as not to damage its content;
- do not, for any reason, remove, tear or rewrite parts of the manual;
- keep the manual away from humidity and heat;
- if the manual is lost or partially damaged and therefore the contents can no longer be read entirely, it is advisable to request a new manual from the manufacturer by communicating the code found on the cover or the serial number of the unit.

Pay utmost attention to the following symbols and their meaning. Their purpose is to highlight specific information such as:

SAFETY SYMBOLS	
 <b>WARNING</b>	With reference to additions or recommendations for the correct use of the unit.
 <b>DANGER</b>	With reference to dangerous situations that may occur with the use of the unit to guarantee personal safety.
 <b>ATTENTION</b>	With reference to dangerous situations that may occur with the use of the unit to prevent damage to property and to the unit itself.

### 3.2 Preamble

The operating rules described in this manual are an integral part of the unit supply.

These rules are also intended for the previously trained operator specifically to operate this type of unit and contain all the necessary and important information for operating safely and optimal, proper use of the unit.

Hurried and incomplete training leads to improvisation, which is the cause of many accidents.

Before starting to work, read through and strictly observe the following suggestions:

- the operator must always have the instructions manual at his disposal;
- plan each action carefully;
- before starting work, make sure the safety devices function correctly and you have no doubts on how they work; otherwise, do not start-up the unit;
- carefully observe the warnings relating to special hazards contained in this manual;
- preventive and thorough maintenance guarantees constantly high operating safety for the unit. Never delay repairs and always have them carried out solely by qualified personnel; only original spare parts are to be used.

### 3.3 Liability

The MANUFACTURER cannot be held liable for any personal accident or damage to property, which may arise from:

- failure to comply with the instructions provided in this manual regarding unit management, use and maintenance;
  - violent actions or incorrect manoeuvres when performing maintenance on the unit;
  - alterations made to the unit without prior written authorisation from the MANUFACTURER;
  - incidents beyond the normal and correct use of the unit.
- In any case, if the user attributes the incident to a defect in the unit, he must prove that the damage caused was a main and direct consequence of this “defect”.

#### **ATTENTION**

- When installing or servicing the unit, the rules stipulated in this manual must be complied with together with those on board the unit and in any case all necessary precautions must be taken.
- The presence of pressurised fluids in the refrigerant circuit and of electrical components can create hazardous situations during installation and maintenance.
- Therefore, only qualified personnel may perform work on the unit.
- THE UNIT MUST BE STARTED UP FOR THE FIRST TIME **ONLY BY QUALIFIED PERSONNEL** AUTHORISED BY THE COMPANY PLACING IT ON THE MARKET.
- FAILURE TO COMPLY WITH THE RULES STIPULATED IN THIS MANUAL AND ANY ALTERATION TO THE UNIT

WITHOUT PRIOR AUTHORISATION WILL **IMMEDIATELY MAKE THE WARRANTY NULL AND VOID.**

- Before performing any work on the unit, ensure it has been disconnected from the power supply.
- For maintenance service or repairs always and exclusively use original spare parts. **THE MANUFACTURER** declines all responsibility for damages that may occur due to non-compliance with the above.
- The unit is covered by the warranty according to the contractual agreements established at the time of sale.
- However, the warranty is rendered null and void if the regulations and user instructions stipulated in this manual are not complied with.
- In the event of a fault, do not try to repair it yourself or have an unauthorised technician perform the repairs. The warranty will otherwise be rendered null and void.

### 3.4 Intended use

ETH heat pump is a multipurpose heat pump with total heat recovery, capable of exchanging heat both with the air source and the external ground source by giving the priority to the source which provides the highest efficiency. In this way, without any kind of combustion and flame, it allows the entire home to be heated or cooled and to produce technical hot water for sanitary purposes in a totally autonomous way, in priority or in total recovery in cooling mode.

#### **DANGER**

- Place the unit in environments where there is no risk of explosion, corrosion or fire.
- Improper use could cause serious repercussions on the unit.
- All routine and special maintenance operations must be performed with the unit off and the power supply disconnected.
- Wait approximately 30 minutes after switching off the unit before carrying out any maintenance operations to avoid burns.
- The unit is only for outdoor use.

#### **ATTENTION**

- Before performing any work on the unit, each operator must be perfectly aware of how the unit and its controls work and must have read and understood all the technical information in this manual.
- It is forbidden to use the unit in conditions or for uses other than what is indicated in this manual and the **MANUFACTURER** may not be held responsible for breakdowns, accidents or injuries due to failure to comply with this prohibition.
- Do not repair high pressure pipes with welds.
- It is forbidden to tamper with, alter or modify, even partially, the systems or equipment described in the instruction manual, and in particular, the guards and warning symbols required for personal safety.
- It is also forbidden to operate in manners different from those indicated or fail to perform operations necessary for safety reasons.
- Safety instructions are particularly important, as well as general information contained in this manual.

## 3.5 Identification of the unit

Each unit has an identification plate that is located on its frame, which shows all the data necessary for the installation, maintenance and traceability of the machine.

Note the model, the serial number, the final refrigerant charge and the machine reference diagrams attached to this manual so that they can be easily found in case of data plate damaging and system maintenance.



Manufactured by HIRef S.p.A.

Via Spagna, 31-33 Z.I.-35020 Tribano(PD)-Italy Tel.+390499588511-Fax+390499588522  
P.I.e C.F. 04225420281  
e-mail: info@hiref.it Web: www.hiref.it



2761

Modello - Model	
Matricola - Serial Number	
Codice ID - Code ID	
Data di Produzione - Date of production	
Categoria PED/2014/68/EU Category	
Modulo di valutazione - Conformity Module	
Max pressione ammissibile	
Max allowed pressure PS [bar-rl]	
Max pressione ammissibile lato bassa	
Max allowed pressure low side PS [bar-rl]	
Max/Min temp. stoccaggio - Max/Min storage temp	
Potenza frigorifera - Cooling capacity*	
EER*	
Potenza termica - Heating capacity*	
COP*	
Refrigerante - Refrigerant [ASHRAE 15/1992]/GWP	
Carica refrigerante - Refrigerant charge [kg]	
Refrigerante aggiunto - Refrigerant added [kg]	
Carica totale - Total Charge [kg]	
Ton. di CO2 equivalenti-Tonnes of CO2 equivalent	
Tar press. lato ALTA-HIGH pressure Switch Set [bar-rl]	
Tar press. lato BASSA-LOW pressure Switch Set [bar-rl]	
Taratura valvola sicurezza refrigerante	
Safety valve refrigerant Set [bar-rl]	
Taratura valvola sicurezza acqua	
Safety valve water side Set [bar-rl]	
Alim. elettrica principale-Main Power supply	
Alim. elettrica secondaria-Secondary Power supply	
Potenza massima assorbita - Max. absorbed power [kW]	
Corrente massima - Full load ampere FLA [A]	
Corrente di spunto - Starting Current LRA [A]	
Schema elettrico - Wiring diagram	
Schema frigorifero - Refrigeration diagram	
Peso a vuoto - Empty weight [kg]	

\* EN14511-2

Contains fluorinated greenhouse gases

## 3.6 General instructions

#### **ATTENTION**

- This manual must be stored carefully in a place that is known by the user of the unit, managers and operators in charge of transport, installation, use, maintenance, repairs and final dismantling.
- This manual indicates the intended use of the unit and provides instructions regarding transport, installation, assembly, adjustment and use. It provides information regarding maintenance, ordering spare parts, the presence of residual risks and personnel training.
- Please note that the use and maintenance manual is not intended to be a substitute for adequate user experience.
- This manual represents a reminder of the main operations to be performed by operators who have received



specific training, for example by attending training courses held by the manufacturer, with reference to particular maintenance operations.

- This manual is to be considered an integral part of the unit and must be stored near the unit in a special container until the unit is eventually demolished.
- Request a new copy from the manufacturer if it is lost or deteriorated.
- Make sure all the users have thoroughly understood the operating instructions together with the meaning of any symbols on the unit.
- Possible accidents can be avoided by following these technical instructions drafted in accordance with the Machinery Directive 2006/42/EC and subsequent additions.
- In any case, always comply with national safety regulations.
- Do not remove or damage the safety devices, labels and notices, especially those imposed by law.
- Adhesive labels intended for safer use are applied to the unit, therefore, it is very important to replace them if they become illegible.
- This manual reflects the applicable technology at the time the unit is sold and cannot be considered inadequate due to subsequent updates based on new experience.
- The **MANUFACTURER** has the right to update the production and manuals, without being obliged to update previous production and manuals, except for exceptional cases.
- Any updates or additions to this use and maintenance manual are to be considered an integral part of the manual and may be requested via the contact phone numbers listed in this manual.
- Contact **THE MANUFACTURER** for further information and to submit any proposals on how to improve the manual.
- **THE MANUFACTURER** kindly asks you to report the address of the new owner in case of transfer of the unit, in order to facilitate forwarding any supplements of the manual to the new user.

## 4 SAFETY INSTRUCTIONS

### ATTENTION

The safety instructions below should be read carefully after understanding the operation of the unit, and before proceeding with its installation, commissioning and/or maintenance.

Electrical equipment must be installed, used, and maintained by qualified personnel.

Personnel must have skills and knowledge relating to the construction, installation and operation of electrical equipment and must have received adequate safety training.

### 4.1 General cautionary notes

The operating rules contained in this manual are an integral part of the unit supply and are valid exclusively for the ETH units. They contain all the useful and necessary information for safe operation and ideal, recommended use of the unit. The declaration of conformity is attached individually to the literature kept on the machine, usually inside the control cabinet. Please follow the instructions given below:

- Read the instructions manual carefully and consider it an integral part of the unit;
- Every unit operator and maintenance technician must carefully read the entire manual and comply with that stipulated therein;
- the employer is obliged to ensure that the operator satisfies the aptitude requisites for unit operation and has carefully read the manual;
- The instructions manual must be readily available to operating personnel and maintenance technicians;
- Keep the manual throughout the life of the unit;
- Make sure that any update is included in the text;
- Hand the manual to any other user or subsequent owner of the unit;
- Use the manual so that the contents are not damaged - entirely or in part;
- Do not, for any reason, remove, tear or rewrite parts of the manual;
- Keep the manual with care; it must be available at the unit, stored in a special container, to protect it from moisture and heat, until final scrapping of the machine. The location where the manual is kept must be known to the user of the unit, to the managers, to the persons in charge of transportation, installation, use, maintenance, repairs, and end-of-life dismantling and scrapping. If the manual is lost or partially damaged, so that it is no longer possible to read all of its contents, it is advisable to request a new one from the manufacturer;
- Avoid hasty and incomplete preparation that lead to improvisation and cause many accidents. Pay close attention to the safety symbols shown in the table on the previous page and to their meaning.

Before starting to work, read through and strictly observe the following suggestions:

- The operator must always have the instruction manual readily available at any time;
- Plan each action carefully;

- Before starting work, make sure the safety devices function correctly and you have no doubts on how they work; otherwise, do not start-up the unit;
- Carefully observe the warnings relating to special hazards contained in this manual;
- Preventive and thorough maintenance guarantees constantly high operating safety for the unit. Never delay repairs and always have them carried out solely by qualified personnel; only original spare parts are to be used.

**THE MANUFACTURER** shall not be liable for any accident to persons or property which may occur due to:

- Failure to comply with the instructions provided in this manual regarding unit management, use and maintenance;
- Violent actions or incorrect manoeuvres when performing maintenance on the unit;
- Alterations made to the unit without prior written authorisation from the **MANUFACTURER**;
- Events that are, in any case, unrelated to the normal and correct use of the unit;
- In any case, if the user attributes the incident to a defect in the unit, he must prove that the damage caused was a main and direct consequence of this “defect”.

This manual reflects the state of the art at the time of unit sale: The **MANUFACTURER** reserves the right to update its products and manuals without any obligation to update earlier products and manuals, except in special circumstances. These may not be considered inadequate only because they have been subsequently updated based on new experience.

### ATTENTION

When installing or when working on the chiller unit, it is necessary to strictly comply with the regulations contained in this manual, observe the instructions provided on-board the unit and in any case, adopt all the necessary precautions.

- The presence of pressurised fluids in the refrigerant circuit and of electrical components can create hazardous situations during installation and maintenance.
- Any action on the unit must be carried out by qualified and authorised personnel. In the event of a fault, do not attempt repairs on your own and do not let unauthorised technicians carry out repairs, or the guarantee will no longer be valid.
- The initial start-up must be carried out exclusively by qualified personnel authorised by the marketing entity (see annex).
- Before performing any work on the unit, be sure to have disconnected power supply.
- For maintenance service or repairs always and exclusively use original spare parts. **THE MANUFACTURER** declines all responsibility for damages that may occur due to non-compliance with the above.
- The unit is guaranteed according to the contractual agreements entered into upon its sale: however, failure to comply with the rules and instructions contained in this manual and any modification in the unit not previously

authorised, will cause an immediate loss of guarantee validity.

- This manual describes the intended use of the unit and provides instructions for its handling, installation, assembly, adjustment and use. It supplies information on the maintenance schedule, how to order spare parts, the presence of residual risks, and staff training. Therefore, before handling, installing, using or carrying out any maintenance on the unit, read the manual very carefully.
- Please note that the use and maintenance manual is not intended to be a substitute for adequate user experience. For particularly complex maintenance operations, this manual serves as a reminder of the main tasks to carry out for operators having received specific training, for example, in the form of training courses delivered by the manufacturer.
- Please ensure that all users have fully understood the directions for use and the meaning of any symbols provided on the unit.
- Possible accidents can be avoided by following these technical instructions drafted in accordance with the Machinery Directive 2006/42/EC and subsequent additions.
- In any case, always comply with national safety regulations.
- Do not remove or damage guards, decals, stickers and wording, especially any that are required by law.
- Adhesive plates are applied to the unit to make it safer to use, therefore, it is very important to replace them if they are no longer legible.

#### **WARNING**

The electrical wiring, hydraulic and refrigeration diagrams and the technical data shown in this manual are supplied for this product range. For detailed information on specific models, refer to the specific documentation attached to the each product. Any updates or additions to this use and maintenance manual are to be considered an integral part of the manual and may be requested via the contact phone numbers listed in this manual. Contact **THE MANUFACTURER** for further information and to submit any proposals on how to improve the manual. **THE MANUFACTURER** kindly asks you to report the address of the new owner in case of transfer of the unit, in order to facilitate forwarding any supplements of the manual to the new user.

## 4.2 Safety prescriptions

### 4.2.1 Thoroughly know the unit

The unit must only be used by qualified personnel, who are expected to know the arrangement and function of all controls, instruments, indicators, indicator lights and various data plates.

### 4.2.2 Wear protective clothing

Each operator must use personal protective equipment such as gloves, headgear, safety goggles, safety shoes, and hearing protection.



### 4.2.3 Use safety equipment

A first aid kit and a fire extinguisher must be placed near the unit.



### 4.2.4 Fire extinguisher and a first aid kit

Check the presence and location of the fire extinguisher. Regularly check that the fire extinguishers are charged and their operating instructions are clearly understood.

It is required to be aware of where the first aid box is kept. Periodically check that the first aid kit is stocked with disinfectants, bandages, drugs, etc.

The personnel must know what to do in the event of a fire. Make sure that emergency help phone numbers are readily available.

In the event of a fire, use a fire extinguisher in compliance with the regulations in force. Contact the fire department.

#### **WARNING**

The owner of the building where the unit is installed must provide the required fire extinguisher.

#### 4.2.5 General precautions

The Machinery Directive 2006/42/EC provides the following definitions (Annex 1.1.1.1):

**DANGER ZONE:** any area next to and/or inside a machine, where the presence of an exposed person constitutes a risk for the safety and health of said person.

**EXPOSED PERSON:** any person found entirely or partially within a danger zone.

**OPERATOR:** the person (or persons) appointed to install, set up, adjust, maintain, clean, repair and transport the machine.

##### **WARNING**

- Before carrying out any operation or maintenance on the unit it is mandatory to read and follow the instructions given in the use and maintenance manual. During the actual work, it would be too late: any not recommended or wrong operation could then cause serious damage to people or property.
- The employer must inform in detail all operators about the risks of accidents and particularly about risks related to noise, required personal protective devices and general accident prevention rules provided by laws or international standards and national standards in the Country of destination of the unit.
- All the operators must comply with international accident prevention regulations and those applicable in the country of use in order to prevent potential accidents. Please be reminded that the European Union has issued some directives concerning the safety and health of workers, among which the directives 89/391/EEC, 89/686/EEC, 89/654/EEC, 2009/104/EC, 89/656/EEC, 2003/10/EC, 92/58/EEC and 92/57/EEC that each employer has an obligation to observe and to enforce. In the event that the unit is installed outside the European union, always refer to the regulations in force in the country of installation.
- Before starting any work on the unit, each operator must be perfectly familiar with its operation and its controls, and have read and understood all the information contained in this manual.

##### **ATTENTION**

It is forbidden to tamper with or replace parts of the unit unless this has been expressly authorised by the **MANUFACTURER**.

The use of accessories, tools, consumables or spare parts other than those recommended by the **MANUFACTURER** and/or specified in this manual may be a hazard to operators and/or damage the unit.

Any alteration to the unit that is not specifically authorised by the **MANUFACTURER** relieves the manufacturing company from any civil or criminal liability.

##### **WARNING**

- It is strictly forbidden to remove or tamper with any safety devices.
- Any installation, ordinary and extraordinary maintenance operations must be carried out with the unit stopped and without power supply.
- Once the unit has been cleaned, the operator must check that there are no worn or damaged parts or parts that

are not safely fixed, or if this is the case, ask the maintenance staff to fix the problem. Special attention must be paid to the state of repair of the pressurised pipes or other parts exposed to wear. It must also be ensured that there are no leaks of fluid, or other dangerous substances. In these cases, it is forbidden for the operator to restart the unit before the situation has been remedied. If any of these occurrences are detected, the operator, before leaving the unit unattended, must display a warning sign indicating that maintenance is in progress and it is forbidden to start the unit.

- The use of flammable fluids in cleaning operations is prohibited.
- Periodically check the condition of the data plates and arrange, if necessary, for them to be restored.
- The operator work place must be kept clean, tidy and free from any objects that may limit unhindered movement.
- Operators should avoid operating the device from unsafe, uncomfortable positions that may affect their balance.
- Operators must be aware of possible risks of entrapment and entanglement of clothes and/or hair in moving parts; it is recommended to wear caps over long hair.
- Wearing chains, bracelets and rings can also be dangerous.
- The workplace must be adequately lit for the intended operations. Insufficient or excessively bright lighting can imply safety risks.
- The instructions, accident-prevention rules and warnings contained in this manual must be observed at all times.

#### 4.2.6 Safety information

The units have been designed and built according to the current state of the art and the technical rules currently applicable to fluid chillers and heat pumps and/or fluid chillers with free-cooling exchange intended for cooling water or water and anti-freezing agent mixtures, for housing air conditioning and industrial cooling systems. Compliance with the laws, provisions, prescriptions, orders and directives in force for these machines has been ensured.

The materials and the equipment parts used, as well as the production, quality assurance and control processes meet the highest safety and reliability requirements.

By using them for the purposes specified in this user manual, by operating them with the required diligence and performing accurate maintenance and overhauling in a workmanlike manner, consistent performance and functionality and durability can be ensured.

#### 4.2.7 Accident prevention

The **MANUFACTURER** will not be liable for accidents, during the use of the unit, due to failure by the user to comply with laws, provisions, prescriptions and regulations applicable to fluid chillers and heat pumps and/or fluid chillers with free-cooling exchange system.

#### 4.2.8 Operational safety

The **MANUFACTURER** will not be responsible in case of malfunctions and damage if the unit:

- is used for purposes other than those intended;
- Is not handled and maintained according to the operating rules specified in this manual;
- It does not regularly and consistently receive maintenance as prescribed or non-original spare parts are used;

- Is modified or some components are replaced without the **MANUFACTURER's** written authorisation, especially when the effectiveness of the safety systems has been altered or minimised on purpose;
- It is used outside the permissible temperature range.

#### 4.2.9 Tools

Use only tools prescribed by the unit manufacturer; in order to avoid personal injury, do not use worn or damaged, low quality or makeshift tools.

If tools not recommended or modified without authorisation are used, the manufacturer will no longer be liable for damages caused.

#### 4.2.10 Personnel

Ordinary maintenance prescribed in this manual must only be performed by authorised and trained personnel. For the maintenance or overhauling of components not specified in this manual, contact the **MANUFACTURER**.

#### 4.2.11 Keep the unit clean

Oil and grease stains, misplaced tools or broken pieces are harmful to people as they can cause slipping or falls. Always keep the area where the unit is installed clean and tidy.

Do not use diesel fuel, oil or solvents to clean the unit as the first two leave an oily film that makes it easier for dust to stick, while solvents (even milder ones) damage the paint finish and cause rusting.

If a jet of water penetrates the electrical equipment the contacts oxidise and the unit may malfunction. Therefore, do not use jets of water or steam on the sensors, connectors or any electrical part.

#### 4.2.12 Warning plates

Before starting any maintenance operation, turn off the unit. If other people start the unit and operate the control buttons while maintenance operations are being performed, serious injury or even death may result.

To avoid these dangers, before carrying out maintenance, hang caution signs around the unit.

#### 4.2.13 Warnings for inspections and maintenance

Display a sign with the warning: "**INSPECTION IN PROGRESS**" on all sides of the unit.

Check the unit carefully following the list of operations contained in this manual.



#### 4.2.14 Care and maintenance

The cause of damages and accidents is often attributable to wrong maintenance, such as:

- Inadequate refrigerant;
- Poor cleaning in the unit setting;
- Circuit inefficiency (damage to the finned coils, pipe connections, tightening of pipes, screws, etc.).

Carry out maintenance work as required: this is also critical for your own safety.

Never postpone scheduled repairs.

Only assign skilled or authorised personnel to repair tasks.

Always observe the following safety rules, even when you are thoroughly familiar with the operations involved:

- Always keep the unit and the surrounding area clean;
- Before beginning to work, check the perfect efficiency of protective devices;
- Make sure that no unqualified or not specially appointed persons enter the unit operating area.

## 5 DESCRIPTION OF THE PRODUCT AND TECHNICAL DATA

### 5.1 Main components

#### » Main components

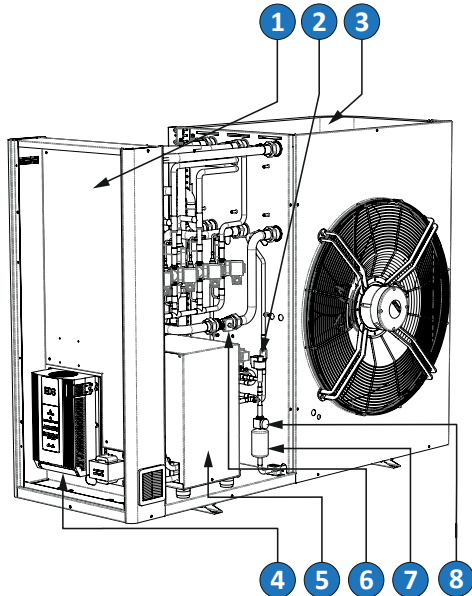

1. Electric control board
2. Expansion valve
3. Finned battery
4. Inverter
5. Compressor
6. Flowmeters
7. Filter
8. Liquid level indicator

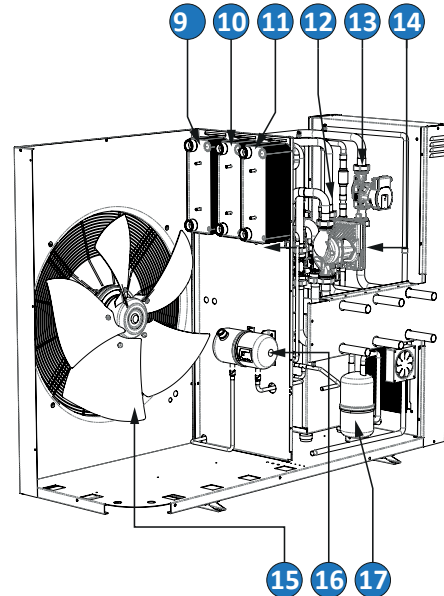

9. Source heat exchanger
10. User side heat exchanger
11. DHW side heat exchanger (M version only)
12. User circulation pump
13. DHW circulation pump (M version only)
14. Source circulation pump
15. Fan
16. Liquid separator
17. Receiver

### 5.2 Operating limits

#### 5.2.1 Limits for the temperature of water produced

The units of the series can work with mixtures of water and glycol, with percentages of the latter up to 40%. If this percentage is exceeded, please contact the sales department for a special selection of pumps.

#### **ATTENTION**

Using glycol is necessary in all cases in which the temperature of the heat transfer fluid drops below 5°C, i.e. even when the unit is switched off or only running in summer mode, should this temperature condition occur. This will prevent water freezing and the resulting internal damage to components.

#### **WARNING**

The percentage of glycol must be selected according to the lowest expected temperature. In the following tables, the freezing temperatures of the mixture are given as a function of the glycol content and the recommended amount of glycol - respectively.



% by weight of glycol	Freezing temperature of the mixture with ethylene glycol (°C)	Freezing temperature of the mixture with propylene glycol (°C)	Adjustable antifreeze temperature set for the mixture with ethylene glycol (°C)	Adjustable antifreeze temperature set for the mixture with propylene glycol (°C)
0	0	0	5	5
10	-3	-3	2	2
15	-5	-5	0	0
20	-8	-7	-3	-2
25	-11	-10	-6	-5
30	-14	-13	-9	-8
40	-22	-21	-17	-16

**WARNING**

The use of glycol will determine a change in terms of heating capacity, water flow and pressure drop.

The corrective factors to be used according to the percentage of glycol are shown in the following table.

Glycol percentage by weight	%	0%	10%	20%	30%	40%
ETHYLENE-BASED	Developed heat capacity correction factor	1,00	1,00	0,99	0,99	0,98
	Water flow correction factor	1,00	1,05	1,09	1,14	1,20
	Pressure drop correction factor	1,00	1,16	1,35	1,58	1,86
PROPYLENE-BASED	Developed heat capacity correction factor	1,00	1,00	0,98	0,97	0,96
	Water flow correction factor	1,00	1,02	1,04	1,07	1,10
	Pressure drop correction factor	1,00	1,11	1,31	1,53	1,78

**ATTENTION**

The freezing temperature of the mixture must be at least 5 °C lower than the minimum temperature expected at the heat pump outlet. Otherwise it is possible to cause the formation of ice inside the evaporator with consequent breakage of the same.

**WARNING**

All the temperatures on the perimeter of the operating areas can only be reached as transients and if the unit runs beyond these limits for a prolonged time, the software on board will implement corrective actions to restore the unit within the operating limits.

<b>Thermal carrying fluid</b>	water or mixture of water and antifreeze (max 40%)
<b>Maximum water side pressure</b>	6 bar
<b>Maximum pressure on high pressure side [ps]</b>	43,0 bar
<b>Minimum operating temperature</b>	+48 °C
<b>Minimum operating temperature</b>	-20 °C
<b>Maximum pressure on low pressure side</b>	28 bar-r (*)
<b>Supply voltage</b>	+/- 10% compared to plate voltage
<b>Maximum storage temperature</b>	+45 °C
<b>Minimum storage temperature</b>	-20 °C (limit determined by on board electronics)

(\*) this value can be reached only in storage conditions and determines the refrigerant saturation pressure of 28 bar-r on the low pressure side of the circuit, a value which in fact defines the limits.

### Water flow to the evaporator

The nominal flow rate is based on a thermal differential of 5° C between inlet and outlet water, in relation to the cooling capacity provided at the nominal water temperatures (12/7 °C). The maximum allowed flow rate is associated with a thermal differential of 3 °C. Higher flow rate values cause too big pressure drops.

The min flow value allowed is the one belonging to a 8°C temperature differential through the evaporator: minor flow values could cause evaporating temperatures too low for the compressors, with the group stopping or in any case bad distribution and risk of heat exchange in motion not turbulent or not completely turbulent.

### 5.2.2 Operating limits

» ETH operating limits - Cooling mode Air-Water

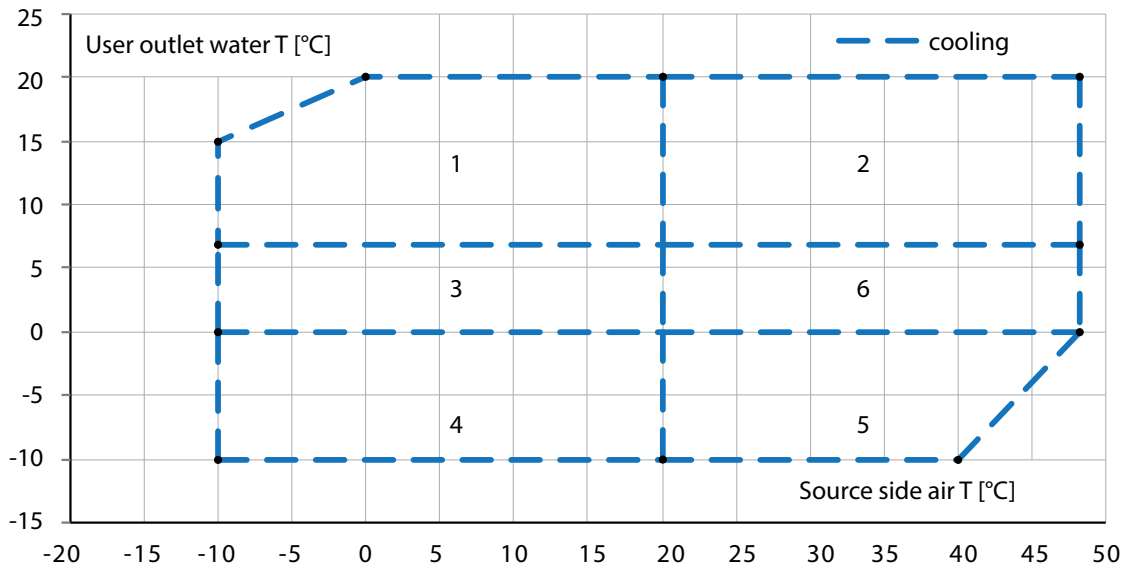

- |   |   |
|---|---|
| 1. Condensation control                           | 4. Condensation control / glycol mix on user side / custom version on request |
| 2. Standard unit                                  | 5. Glycol mix on user side / custom version on request                        |
| 3. Condensation control / glycol mix on user side | 6. Glycol mix on user side  |

» ETH operating limits - Cooling mode Water-Water

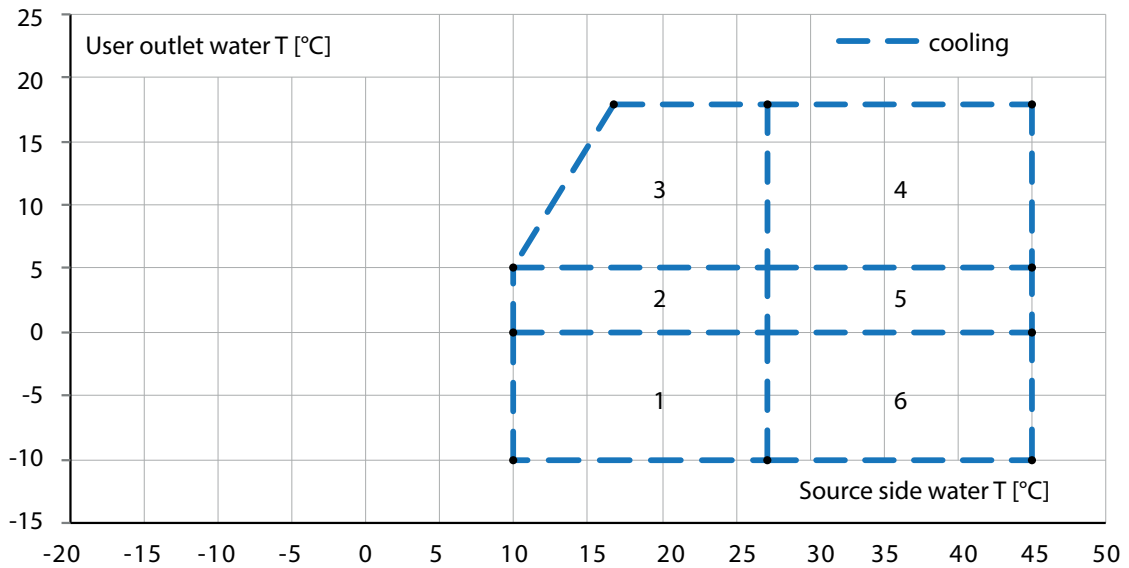

- |  |  |
|--|--|
| 1. Glycol mix on user side / custom version on request | 4. Standard unit                                       |
| 2. glycol mix on user side / condensation control      | 5. Glycol mix on user side                             |
| 3. Condensation control                                | 6. Glycol mix on user side / custom version on request |



» ETH operating limits - Heating mode Air-Water

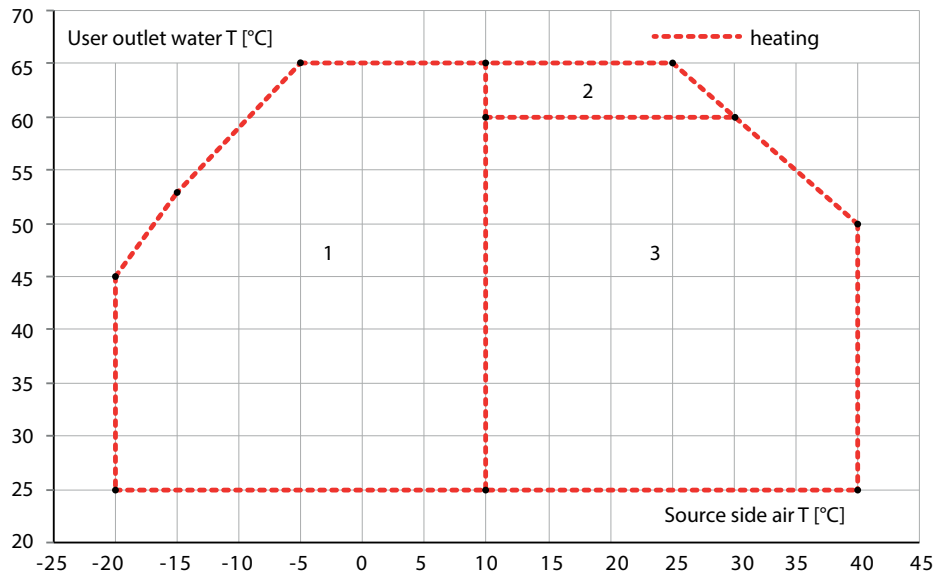

- 1. Standard unit
- 2. Delta T > 7 °C on user side
- 3. Evaporation control

» ETH operating limits - Heating mode Water-Water

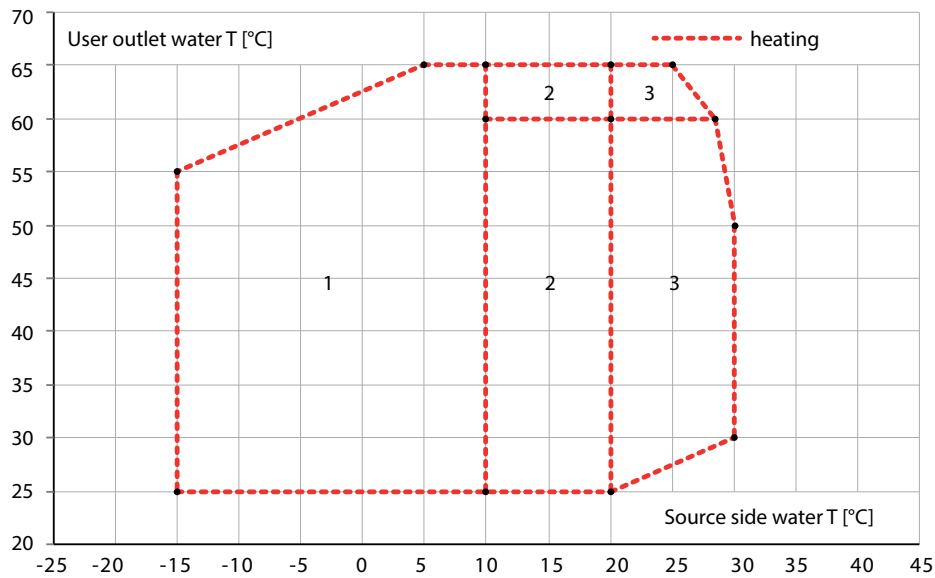

- 1. glycol mix on source side
- 2. Delta T > 7 °C on user side
- 3. Delta T > 7 °C on user side / evaporation control
- 4. glycol mix on source side
- 5. Standard unit

### 5.3 Characteristic curves of the circulation pumps (configurator field 3 and 4)

mounted on the units. Calibration of the safety - control organs.

The graphs collected in this paragraph show the useful head of the high (rosso - - -) and low (blu - - -) head pumps

### 5.3.1 Circulation pumps on user and DHW side

» ETH006

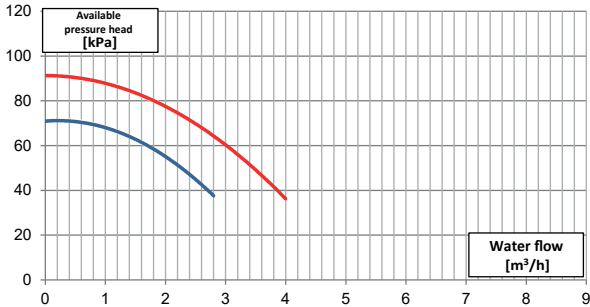

» ETH009

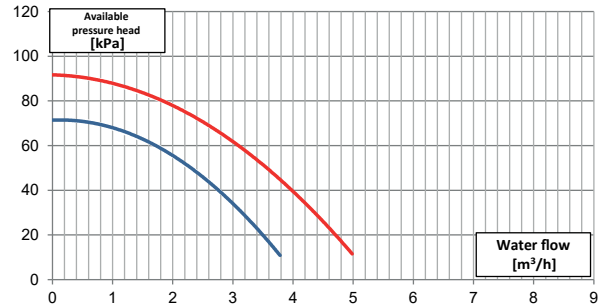

» ETH012

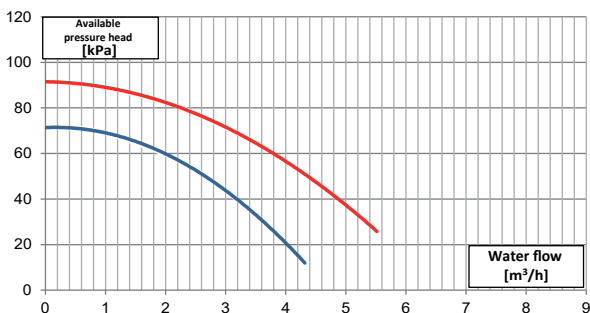

» ETH015

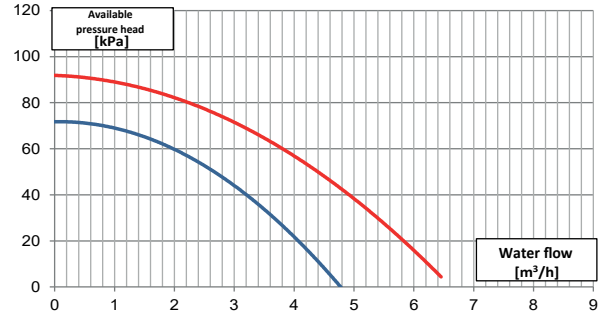

» ETH017

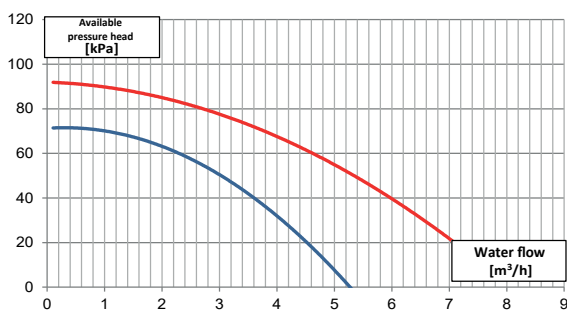

### 5.3.2 Source circulation pumps

» ETH006

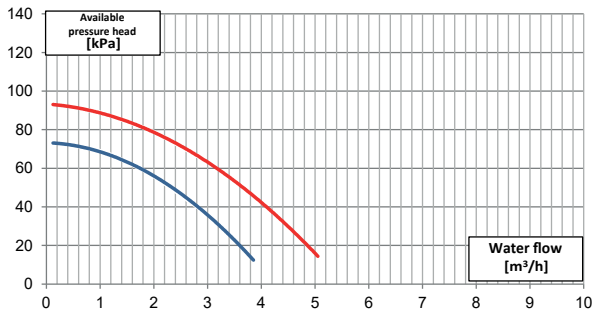

» ETH009

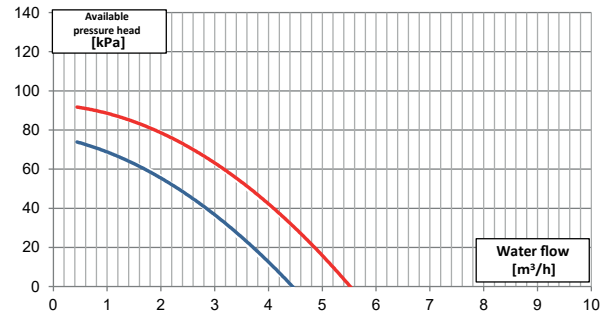

» ETH012

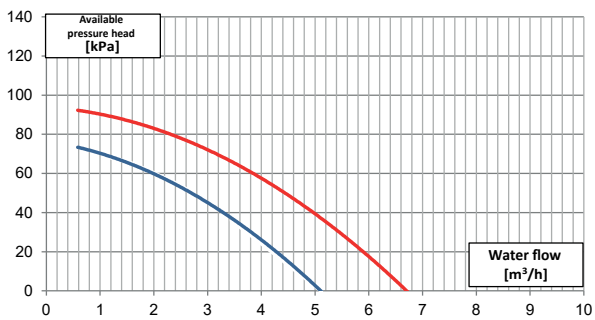

» ETH015

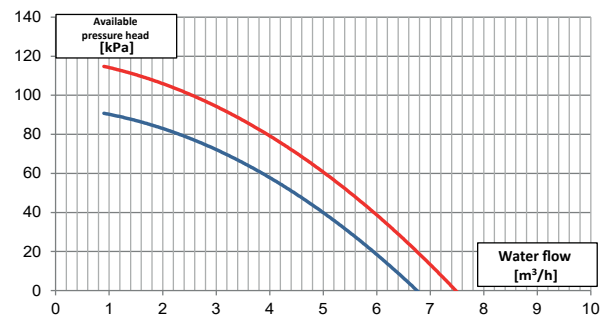

» ETH017

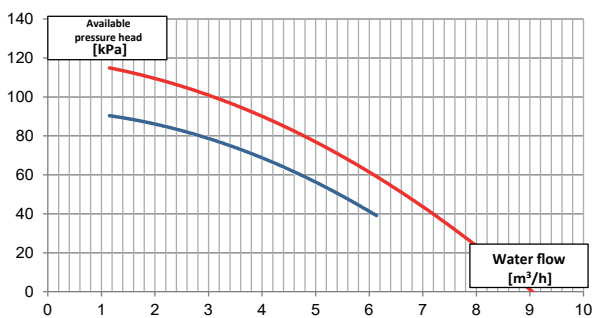

## 5.4 Calibration of control devices

### 5.4.1 General description

All the control devices are set and tested in the factory before the unit is dispatched. However, after the unit has been in service for a reasonable period of time you can perform a

check on the operating and safety devices. The settings are shown in Table Setting of safety-control devices .

**⚠ DANGER**

All service operations on the control equipment must be carried out **EXCLUSIVELY BY QUALIFIED PERSONNEL**: incorrect calibration values can cause serious personal injuries and damage the unit.

Many of the operating parameters and system settings are configured by means of the microprocessor control and are protected by passwords.

#### » Setting of safety-control devices

CONTROL DEVICE	Unit of measurement	ACTIVATION	DIFFERENTIAL	REACTIVATION
Antifreeze alarm	°C	+4	1	Automatic
Maximum safety pressure switch	bar	45	-10	Manual
Maximum admissible PS	bar	HP45/LP28		-
Low pressure alarm	bar	1.5±0.7	1	Automatic
Modulating condensation control	bar	18	10	-
Minimum time between two starts on the same compressor	s	450	-	-
Flow switch alarm delay	s	15 (start-up)	5 (running)	-
Low pressure alarm delay	s	0		-
High-pressure relief valve	bar	55		-
Low pressure safety valve	bar	none		-

### 5.4.2 Maximum pressure switch

The high pressure switch is of the manual reset type and classifiable as category IV under 97/23 EC. It directly stops the compressor when the discharge pressure exceeds the set value.

**⚠ ATTENTION**

Any kind of block or alarm must be promptly reported to the After Sales Service!

**🔧 WARNING**

The high pressure switch must be manually reset; this is possible only when the pressure falls below the set differential (see Table Setting of safety-control devices ).

### 5.4.3 Anti-freeze thermostat function

The anti-freeze sensor situated at the evaporator outlet detects the presence of excessively low temperatures and stops the unit.

Together with the flow switch and low pressure switch, this device protects the evaporator from the risk of freezing as a result of faults in the water circuit.

This device is a function included in the microprocessor control.

**⚠ ATTENTION**

If there are any alarms relating to the intervention of the protections described, the unit must request the intervention of the Authorised Technical Service Centre, otherwise the warranty will be considered null and void.

### 5.4.4 Information about recommended y-shaped filters and 2 way valves

The technical specifications of the Y-shaped filters to be installed at the inlet to the heat pump are listed in the following tables. Always follow the indications on the minimum diameter of the connecting piping reported in 2.1 Minimum diameter of the connection pipes p. 4.

- Bronze body
- SN 5 UNI-EN1982 DIN 50930/6
- Bronze cap CW 617 N - UNI-EN12165
- Body gasket BETAFLEX 71
- Sandblasted finish
- Thread EN-ISO 228/1
- AISI 304 stainless steel rhomboid micro-stretched sheet metal filter

#### » Y-shaped filter

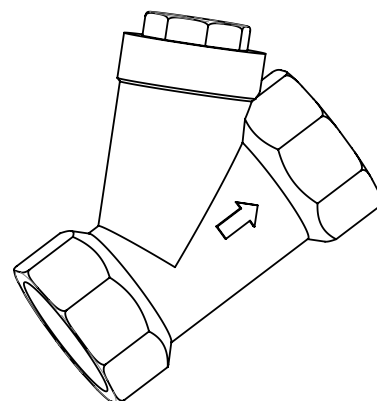

## 5.5 System booklet

---

The charge of the refrigerant fluid determines the obligation on the part of the system manager to keep a system booklet. If the charge exceeds 3 kg of refrigerant fluid, EN378-2 requires the installer to prepare the system booklet which must be regularly updated with any ordinary or extraordinary maintenance.

This is the information that must be inserted:

1. Details of the repair or maintenance
2. Quantity and type of refrigerant that is added / removed from the system
3. If regenerated refrigerant fluid is used, a copy of the analysis must be attached
4. All parts that are replaced or modified must be noted
5. The results of the periodic checks must be noted
6. Long periods of machine downtime must be noted

 **WARNING**

In Italy the booklet is regulated by the D.P.R. 147.

---

## 6 INSPECTION AND TRANSPORT

### 6.1 Inspection

Upon receipt of the unit, check the integrity.  
The machine has left the factory in perfect condition.

**⚠ ATTENTION**

Any damage must be immediately reported to the carrier and noted on the Delivery Sheet before signing this.

**📣 WARNING**





The manufacturer or its agent must be promptly notified of the extent of the damage.

The Customer must submit a written report describing any significant damage.  
Check the integrity of the documents accompanying the unit and of this manual.  
Check for the presence of the wiring diagram.  
After starting up the unit, check the commissioning report.

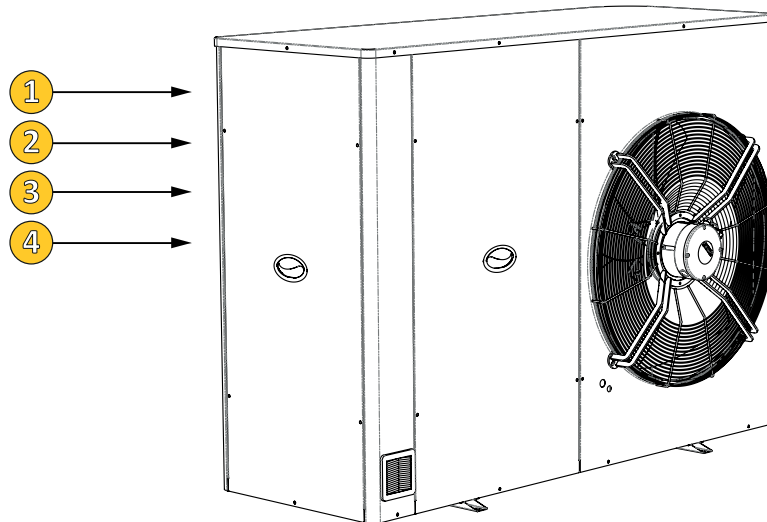
### 6.2 Location of safety data plates

» Safety data plates

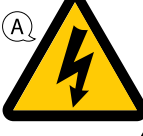

<p><b>1</b></p> <p>A. Warning: danger due to poor familiarity with all the functions of the unit and the resulting risks. B. Read the use and maintenance manual carefully before operating the unit.</p>	<p>(A)   (B)</p>
<p><b>2</b></p> <p>Electric power supply data plate</p>	<p><b>ALIMENTAZIONE ELETTRICA POWER SUPPLY SPG.VERSORGUNGSTEIL 400V/3+N/50Hz</b></p>
<p><b>3</b></p> <p>A. Danger: live parts. B. Danger of burns. C. Danger of mechanical moving parts.</p>	<p>(A)   (B)</p> <p>(C) </p>
<p><b>4</b></p> <p>Refrigerating liquid</p>	<p><b>R454B</b>    <b>R410A</b></p>

### 6.3 Residual risk areas

protected with guards due to specific features of the unit. Each operator must be aware of the residual risks on this unit in order to prevent potential accidents.

**⚠ DANGER**

It has not been possible to eliminate certain residual risks during the design phase, found in some areas of the unit, or

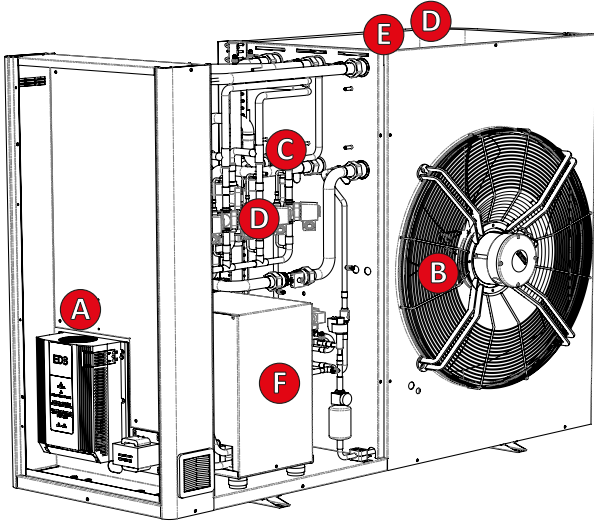

<p><b>A</b> Risk of short circuit and fire <b>B</b> Impact and abrasion hazard in fan area <b>C</b> Danger of explosion due to the presence of pressurised circuits</p>	<p><b>D</b> Danger of pollution due to the presence of refrigerant in the circuit <b>E</b> Danger of cutting injuries near finned exchangers <b>F</b> Danger of burns due to the presence of high temperature pipes</p>
---	---

**⚠ WARNING**

In order to avoid the risks listed above it is essentially important to:

- A. Set the control panel according to the manufacturer's instructions.
- B. Not place metal objects inside the electrical control panel.
- C. Not store flammable materials near the machine.
- D. Do not alter any component of the cooling circuit.
- E. Not let the machine work outside the limits indicated by the manufacturer.

- F. Dispose of all the materials that make up the machine correctly, use suitable equipment for the recovery of the refrigerant gas (see chapter 7 Retiring the unit p. 25).
- G. Not touch the internal components during operation without adequate protection.

---

## 6.4 Lifting and Conveyance

---

During the unloading and positioning of the unit, be extremely careful to avoid bumps and knocks or sudden movements. Factory handling must be carried out with the utmost care, avoiding using any machine components for support.

 **ATTENTION**

In all lifting operations make sure that the unit is securely anchored in order to prevent accidental falls or overturning.

Do not tilt, overturn or drag the unit during transport and installation.

The unit must only be handled exclusively by forklift.

---

## 6.5 Unpacking

---

 **ATTENTION**

The unit packaging must be carefully removed avoiding possible damage to the machine.

The packaging materials are of a different nature: wood, cardboard, nylon etc. Refer to the next paragraph for the correct disposal of the packaging.



## 7 RETIRING THE UNIT

When the unit has reached the end of its expected working life and therefore needs to be removed and replaced, a number of precautions must be followed:

- the refrigerant gas that it contains should be recovered by specialised personnel and sent to a waste collection facility;
- the lubrication oil of the compressors must also be recovered and sent to special collection centres;
- the structure and the various components, if not reusable, must be demolished and separated according to their product type: this is particularly relevant for copper and aluminium, which are present in fairly high amounts in the machine.

This should be done to facilitate work at the special collection, disposal and recycling centres and to minimise the environmental impact that this operation requires.

### ATTENTION

If the unit, or part of it, has been decommissioned, any of its parts that are likely to cause dangers must be rendered harmless.

Please note that any replacement of unit parts subject to separate waste disposal must always be done by referring to the currently applicable legal provisions.

Please note that it is mandatory to record the loading and unloading of special and toxic-harmful waste.

Collection of special and toxic-harmful waste must be carried out by specially authorized companies.

Disposal of special and toxic or harmful waste must be carried out in compliance with the law provisions in force in the user's country.

For unit scrapping, follow the law prescriptions in force in the user's country. Before demolition ask the appointed organism to inspect the unit and write a report.

Finally, carry out scrapping according to the law in force in the country of use.

### WARNING

Dismantling, disposal and scrapping operations must be carried out by qualified personnel.

## 7.1 Environment protection

In general, the laws regulating the use of substances that damage the stratospheric ozone layer and the gases responsible for the greenhouse effect in force in the various countries provide that it is forbidden to disperse refrigerant gases in the environment and request their originators to recover them and return them, at the end of their service life, to the retailers or to special collection centres.

The refrigerant, although not harmful to the ozone layer, is listed among the substances responsible for the greenhouse effect and must therefore be used in compliance with the above obligations.

### ATTENTION

Caution is therefore recommended during maintenance operations in order to minimise refrigerant leaks as much as possible. In any case, refer to the laws in force in the country of installation.

## 7.2 Waste electrical and electronic equipment management

This product falls within the application scope of the Directive 2012/19/EU concerning the management of waste electrical and electronic equipment (WEEE).

Equipment must not be disposed of with household waste as it is made of different materials that can be recycled at special facilities. Please inquire through your municipal authorities as to the location of the eco-friendly waste management sites where waste can be received for disposal and its subsequent recycling as recommended.

Furthermore, please note that, when an equivalent appliance is purchased, the seller is expected to collect free of charge the old product to be disposed of.

The product is not potentially dangerous for human health and the environment, as it does not contain any harmful substances according to the Directive 2011/65/EU (RoHS), but if disposed of freely in the environment, it might adversely affect the ecosystem.

Read the instructions carefully before using the equipment for the first time. It is strongly recommended not to use the product for any purpose other than that for which it was designed, to prevent the risk electric shock if the product is used incorrectly.

### WARNING

The crossed-out wheelie bin symbol on the equipment label indicates that the equipment is compliant with the Waste Electrical and Electronic Equipment (WEEE) Directive.

Disposing of the equipment freely in the environment or illegally disposing of the equipment are punishable by law.

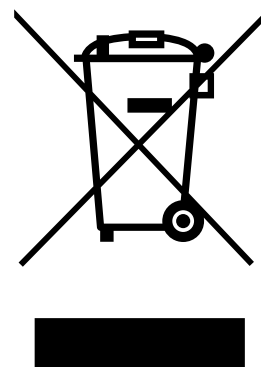

## 7.3 Packaging disposal

The QR Code below is shown on a label on the packaging of the machine, which allows the user to identify the nature of the packaging used in order to follow the correct disposal procedure.



### **ATTENTION**

For disposal of packaging, always refer to local laws that implement Directives 2018/851/UE and 2018/852/UE.

**TECHNICAL MANUAL**

## 8 INSTALLATION

### 8.1 Positioning and installation

#### 8.1.1 Positioning and minimum spaces of respect

**ATTENTION**

The spaces indicated in the dimensional drawings must be complied with for the units to function properly and routine maintenance to be performed.

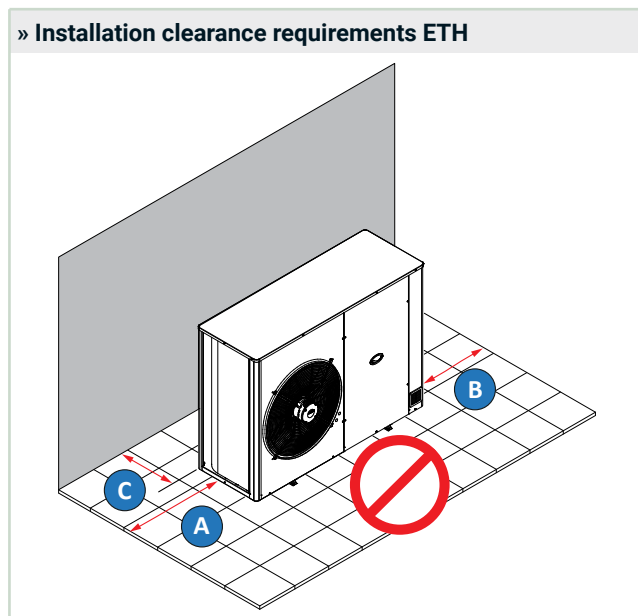

	A [mm]	B [mm]	C [mm]
Clearance spaces	800	800	300

**ATTENTION**

The positioning of the unit that does not respect the minimum spaces indicated in the following paragraph without the explicit authorization of Eneren will result in the immediate voidance of the guarantee.

#### 8.1.2 Unit installation

You should bear in mind the following aspects when choosing the best site for installing the unit and the relative connections:

- Size and origin of water pipes;
- power supply location;
- accessibility for maintenance or repairs;
- solidity of the supporting surface
- the application limits of the unit:

Maximum (ambient) temperature	°C	48
Minimum (ambient) temperature	°C	-20
Maximum (storage) temperature	°C	42
Minimum (storage) temperature	°C	-20

**ATTENTION**

Make sure the unit is not exposed to much dust and protect it from humidity and salt spray.

It is mandatory to use the anti-vibration mounts supplied.

### 8.2 Quality of the water in the systems

Calcification (solid sediments, especially calcium carbonate) might occur according to the quality of the water, which can be harmful to the hydraulic components inside the unit. This is why there is the need to treat the water of the various circuits using the appropriate softening / desalination, neutralization, pH stabilization equipment.

In the below, there are the values of dissolved substances and water characteristics that must be respected for all hydraulic circuits connected to the unit (source circuit, heating / cooling circuit and domestic hot water circuit):

WATER CONTENT	CONCENTRATION
Alkalinity (HCO <sub>3</sub> <sup>-</sup> )	70 - 300 ppm
Sulphate (SO <sub>4</sub> <sup>2-</sup> )	< 70 ppm
HCO <sub>3</sub> <sup>-</sup> / SO <sub>4</sub> <sup>2-</sup>	> 1.0 ppm
Electrical conductivity	10 - 500 µS/cm
pH*	7.5 - 9.0
Ammonium (NH <sub>4</sub> <sup>+</sup> )	< 2 ppm
Chloride (Cl <sup>-</sup> )	< 30 ppm
Free chlorine (Cl <sub>2</sub> )	< 0.5 ppm
Hydrogen sulphide (H <sub>2</sub> S)	< 0.05 ppm
Carbon dioxide (CO <sub>2</sub> )	< 5 ppm
Total hardness (°dH)	4.5 - 8.5
Nitrate (NO <sub>3</sub> <sup>-</sup> )	< 100 ppm
Iron (Fe)**	< 0.2 ppm
Aluminium (Al)	< 0.2 ppm
Manganese (Mn)**	< 0.05 ppm
Calcium carbonate (CaCO <sub>3</sub> )	< 200 ppm
Phosphate (PO <sub>4</sub> <sup>3-</sup> )	< 2 ppm
Ammonia (NH <sub>3</sub> )	< 0.5 ppm
Temperature (°C)	< 65 °C
Oxygen content	< 0.1 ppm

\*Generally a low pH value (less than 6) increases the risk of corrosion and a high pH (above 7.5) decreases the risk of corrosion  
 \*\*Fe<sup>3+</sup> and Mn<sup>4+</sup> are powerful oxidants and may increase the risk of localized corrosion on stainless steel

**ATTENTION**

These values are to be considered limit values and therefore, they must be verified and respected under penalty of voidance of the guarantee.

### 8.2.1 Filling of the plants

#### ATTENTION

To fill the heating systems, it is advisable to comply with the applicable regulations in force, in particular the VDI-2035 standard.

## 8.3 General guidelines for plumbing connections

Install the following components on the piping:

- temperature and pressure indicators for routine maintenance and monitoring of the unit. Pressure control on the water side allows to assess the correct functioning of the expansion tank and to detect water leakage in advance.
- sumps on inlet and outlet piping for measuring temperatures, and for directly viewing the operating temperatures. They can also be viewed on the display on board the unit (if present).
- shut-off valves (gate valves) to isolate the unit from the water circuit for maintenance.
- metal filter (inlet pipes) with mesh **not exceeding 1 mm**, to protect the exchanger from slag or impurities present in the pipes. **Accessibility for maintenance of the filter itself must be guaranteed.** Avoid positions that may increase the risk of water on the unit.
- air vent valves, placed on the higher parts of the water circuits to bleed the air. The internal pipes of the unit are fitted with manual air vent valves to bleed the unit: **this operation can only be carried out when the unit is disconnected from the power supply.**
- discharge cock and, if necessary, drain tank to empty the system for maintenance or seasonal stops.
- in case of very low temperatures of the water leaving the evaporator, it is possible to add ethylene / propylene glycol **in a percentage not exceeding 30% by weigh** to lower the freezing point; consequently there will be a decline in performance depending on the quantity of glycol, refer to the table in paragraph "5.2 Operating limits p. 14".

#### WARNING

It is extremely important that the water inlet is connected at the height of the "Water Inlet" sign.

Otherwise the evaporator would be exposed to the risk of freezing since the antifreeze thermostat would not be able to perform its function; moreover the reverse cycle would not be respected, resulting in additional risks of malfunctioning. This position does not enable the operation of the water flow control device.

The dimensions and position of the water connections are provided in the dimensional tables and overall drawings.

#### WARNING

The water circuit must be set up in such a way as to guarantee that the nominal flow rate of the water supplied to the evaporator remains constant (+/- 15%) in all operating conditions.

#### ATTENTION

When making the plumbing connections, make sure there are no open flames in proximity to or inside the unit.

#### ATTENTION

For this reason, make sure that the pressure on the pump intake side, where the expansion vessel is positioned, is always above 0.5 Bar with pump running: this helps reduce the risk of cavitation.

It is essential that the installer follows and verifies point by point the procedure indicated below, to prevent any risk of implosion of the tank or cavitation in the pump:

- Drain the expansion vessel until the pressure reaches 0.5 bar;
- Fill the system and pressurise it to approximately + 1 bar in pump suction (pump stopped);
- Allow air to escape from the system;
- Check the pump suction pressure (approximately 1 Bar) and start up the system;
- Stop the pump after 15-30 minutes. Repeat the procedure from step 3 until no more air system noise can be heard.

### Draining the system

Drain outlets must always be set-up in the lower parts of the system. Drain the unit from the connections on the water pipes beneath the pumps.

## 8.4 Buffer tank for heating and cooling circuit

For the correct operation of the machine it is necessary to provide for a decoupling of the flow rates between the machine itself and the system, it is therefore mandatory to install a hot/cold tank in parallel of adequate capacity, sized according to the following relationship:

$$V = \frac{C_c \times \Delta\tau}{\rho \times Sh \times \Delta T \times N_s}$$

<b>V</b>	water content in the user section [m <sup>3</sup> ]
<b>Sh</b>	fluid specific heat [J/(kg/°C)]
<b>ρ</b>	fluid density [kg/m <sup>3</sup> ]
<b>Δτ</b>	minimum time between 2 restarts of the compressors [s]
<b>ΔT</b>	permitted waterT differential [°C]
<b>Cc</b>	refrigerating power [W]
<b>Ns</b>	No. of partial loading steps

The following figure shows the integrated and balanced effect of the storage tank. Its function helps ensure accurate temperature control according to the environmental parameters of the connected groups.

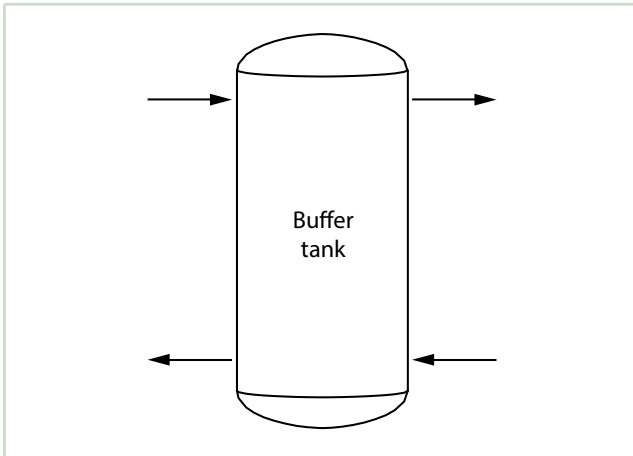

**ATTENTION**

The units are supplied as standard with a device that controls the water flow rate (differential pressure switch or flow meter) on the hydraulic circuit. Any tampering with this device will immediately invalidate the warranty.

## 8.5 Control and safety devices

All control equipment is calibrated and tested at the factory before shipping the machine. However, after the unit has been operating for a reasonable period of time, it is advisable to check the operating and safety devices. The calibration values are shown in the following tables.

**DANGER**

All service operations on the control equipment must be carried out **EXCLUSIVELY BY QUALIFIED PERSONNEL**: incorrect calibration values can cause serious personal injuries and damage the unit.

**ATTENTION**

Many of the operating and calibration parameters of control systems are set by microprocessor control and are password protected.

### Service thermostat

The service thermostat activates and deactivates the operation of the compressor, depending on chilled water (operation as a chiller) or heated water (operation as a heat pump) requirements, via a probe located at the inlet or outlet of the water exchanger.

This device is managed by the microprocessor control and operates with a proportional band of adjustable width.

**WARNING**

For further details please refer to the control manual.

### Control device settings

The calibration values of the control devices set by default for the specific unit are contained in the document "Parameter List", made available to customers by the manufacturer.

On each refrigerant circuit, according to the volumetric capacity of the installed compressors, the PED (Pressure Equipment Directive 2014/68/EU) category of the machine and the refrigerant circuit configuration, there are safety devices for the refrigeration circuit as prescribed by the PED regulation. In particular, this regulation requires designing to be carried out by referring to the technical standard that is closest to the type of item produced; in the case of machines designed for air conditioning or cooling of liquids, the UNI EN 378-2 standard is referred to.

According to this standard, on a case by case basis, on the high and low pressure sides of each refrigerant circuit safety venting valves can be provided, connected to an exchange tap, to protect the pressurised parts and programmed to be activated when the maximum pressure setting is reached on the corresponding side (PS).

The high and low pressure sides have a maximum pressure PS defined by the pressure limit of the components of the machine; this pressure cannot be reached during normal operation of the machine. Further details are given in the diagram of the cooling circuit of the unit.

During normal use, high pressure at the compressor outlet is limited by the high pressure switch, set to the maximum working pressure of the compressor itself, which depends on the unit model and is equal to the PS, in compliance with the UNI standard EN 378-2.

All the safety devices installed on the units are listed and described here below.

### High pressure switch

The high pressure switch stops the compressor when the outlet pressure exceeds the set value.

To check its operation, shut the air flow in the condensers with the compressors running, and check on the compressor delivery pressure gauge (previously installed) that the pressure switch (compressor stop) is activated when the calibration value is reached.

**ATTENTION**

Any shutdown or alarm must be reported immediately to the service department.

**ATTENTION**

Do not attempt to change the setting of the maximum pressure switch. Should the latter fail to trip in the event of a pressure increase, the pressure relief valve will open.

**ATTENTION**

If, during this operation, the safety device is not activated, the second pressure switch in a cascade configuration or a second protection system will operate by switching off the unit; in any case, however, always be sure to be ready to turn the unit off.

Resetting the high pressure switch must be done manually and only when the pressure has fallen below the value indicated by the set differential value (see 5.4 Calibration of control devices p. 20).

**ATTENTION**

The high pressure switch connector does not have the refrigerant sealing needle.

**DANGER**

Do not unscrew the device: this would cause the refrigerant to flow out of the refrigerating circuit.

As an antifreeze protection, a pressure probe is also provided which stops the unit as soon as the pressure falls below the calibration value for a set time.

**WARNING**

For more information related to the operation, the calibration values and the set delays, please refer to the microprocessor manual and the document "Parameter List", supplied with the unit.

**On and off timing**

The compressor switching on and off timing schedules programmed by the manufacturer on the units guarantee correct operation of the compressors and an increased durability and stability of the system. They establish:

- the minimum activation time of a compressor, which must remain on for a time equal to the set time;
- the minimum shutdown time of a compressor, which is not powered back on unless the minimum selected time has not elapsed since the last power-off;
- the delay time between two power-on requests of different compressors, i.e. the minimum time that must elapse between two power-ons of the devices independently of the detected measurement and the setpoint;
- the delay time between two successive power-ons of the same compressor, the minimum time that must elapse between two power-ons of the device.

The purpose of the minimum time intervals is to stabilize the operation of the compressors, ensuring adequate circulation of the oil in the refrigerant circuit and preventing too frequent compressor stops and starts, limiting the maximum number of starts per hour.

**WARNING**

For more information related to the operation, the calibration values and the set delays, please refer to the microprocessor manual and the document "Parameter List", supplied with the unit.

**ATTENTION**

Never change the factory preset time interval: values other than the default ones may cause serious damage to the unit.

**Antifreeze sensor**

The antifreeze sensor, located at the outlet of the plate heat exchanger, detects any temperatures that are too low and stops the unit operation.

This function, together with the flow switch and the low pressure probe protects the exchanger against the risk of freezing due to faults in the hydraulic circuit.

This device is a function included in the microprocessor control

**WARNING**

For further details please refer to the control manual.

**ATTENTION**

If there are any alarms relating to the intervention of the protections described, the unit must request the intervention of the Authorised Technical Service Centre, otherwise the warranty will be considered null and void.

On all units the electronically controlled expansion valve is fitted as part of the standard equipment. This device, if correctly parameterized and controlled by the software, can make the operation of the refrigeration circuit highly effective, which has as a final effect that of decreasing the power absorbed by the system.

When a sudden change in the thermal load occurs, a traditional expansion valve is designed to be in a transient state for 2-3 minutes before reaching its equilibrium condition.

Example:

- One compressor switches off
- Evaporation temperature increases
- Overheating decreases
- Valve closes
- Refrigerant flow decreases
- Refrigerating power decreases
- Evaporation temperature decreases
- ...and so on...

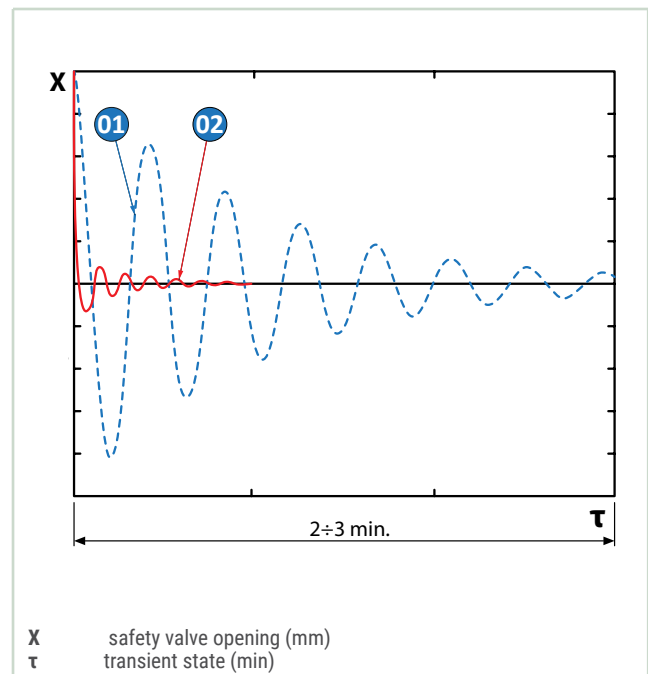

If, on the other hand, there is an electronic expansion valve (2), in case of a compressor switch on or off request:

- the electronic driver pre-positions the valve at a point very near the final equilibrium point;
- the state of balance is quickly reached by small adjustments;

- the expansion valve becomes an active and no longer passive system component;
- the transient state lasts for a very short time;
- globally, the system is more efficient, with higher EER values and therefore, with more considerable savings.

The calibration values of the software and mechanical safety devices are visible respectively:

- in the “Parameter List” document, made available to customers by the manufacturer;
- in the silver label provided on the unit.

### **Paddle flow switch or flowmeters**

The water differential pressure switch or flow meters (user and domestic hot water branch) stop the unit in the event of an excessive reduction in the water flow, thus protecting it from the formation of ice (chiller operation) and excessively high condensation temperatures (heat pump operation).

### **Safety valves**

The water safety valve (source, user and hot water branch) opens when the pressure of the hydraulic system exceeds dangerous values for the integrity of the machine.



## 9 ELECTRICAL CONNECTIONS

### 9.1 General description

#### ATTENTION

The electrical connections must be carried out by qualified personnel.

#### WARNING

All connections must comply with the regulations imposed in the country of installation.

Upstream of the unit's power supply, an adequate sectioning unit must be provided, located **near** the unit, considering the electrical absorption indicated in the wiring diagram supplied with the unit and on the data plate.

#### DANGER

Before carrying out any operation on electrical parts, make sure that there is no applied voltage.

#### ATTENTION

Check that the mains electricity supply is compatible with the specifications (voltage, number of phases, frequency) shown on the unit rating plate.

Power is connected via a more neutral three-core cable and earth cable or unipolar cables (one per phase) plus earth according to the minimum sections indicated in the wiring diagram, an integral part of the documentation supplied with the machine and whose identification code also appears on the characteristic data plate located inside the compressor compartment.

#### ATTENTION

The size of the cable and line protections must conform to the specifications provided in the wiring diagram.

The supply voltage may not undergo fluctuations exceeding  $\pm 10\%$  and the unbalance between phases must always be below 2%.

#### WARNING

The unit must operate within the above values, or the warranty will be invalidated.

Carry out the electrical connections following the wiring diagram provided with the unit, as well as current regulations.

#### ATTENTION

Regarding the differential protection that needs to be installed upstream, it is necessary to use a type B switch that is sensitive to direct currents.

Furthermore, it is preferable that it has also the following characteristics:

1. Adjustable operation threshold;
2. Adjustable operation delay;
3. Dedicated to the heat pump only.

### 9.2 External enabling controls

If you intend to launch a remote control on the unit, you must remove the jumper between the contacts indicated in the wiring diagram and connect the remote control to the terminals themselves [see enclosed wiring diagram].

#### WARNING

All remote controls work with a very low voltage (24 Vac) supplied by the insulating transformer on the electric control board.



### 9.3 Remote summer-winter switching

If you wish to include a remote control for summer/winter switching of the unit, you must remove the bridge between the contacts indicated in the wiring diagram and connect the remote control to the terminals themselves [see annexed wiring diagram].

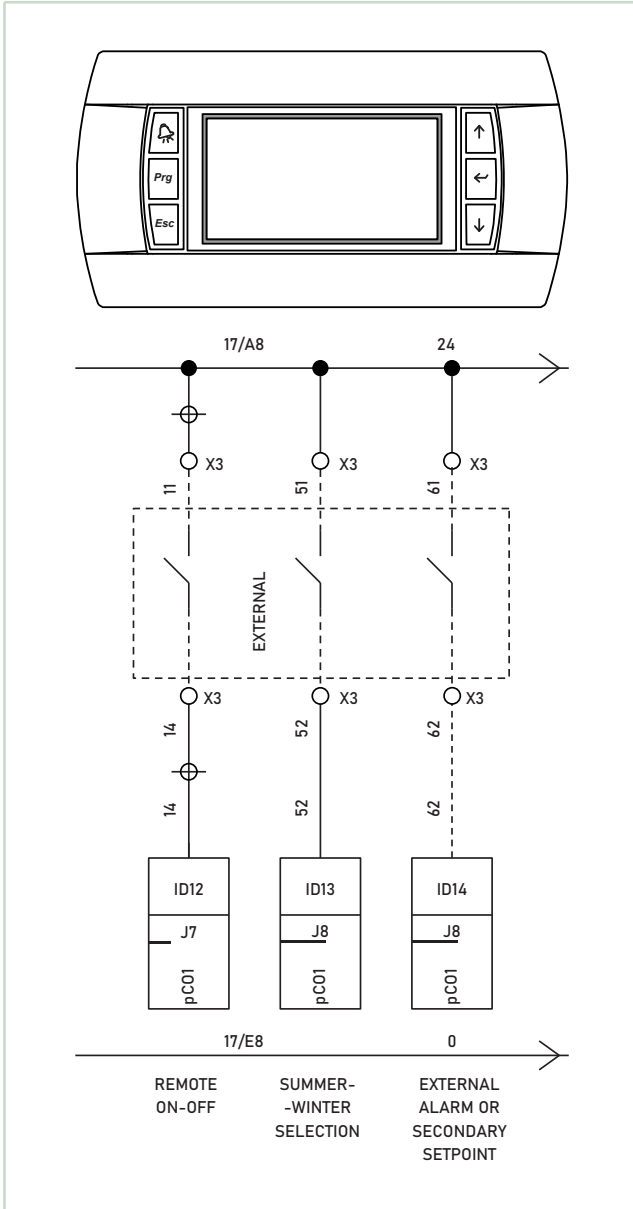
The switching modes are indicated in the microprocessor user manual, an integral part of the accompanying documentation.



**ATTENTION**







If an alarm is triggered and the **ALARM** button  lights up, do not press the **ALARM** button  to reset the alarm and immediately contact our After Sales Service. For the full list of alarms, refer to the documentation enclosed with the unit.

**DANGER**

All service operations on the control equipment must be carried out **EXCLUSIVELY BY QUALIFIED PERSONNEL**: incorrect calibration values can cause serious personal injuries and damage the unit.

The user interface, pCO, consists of an LCD display and 6 keys. It can be used to execute all of the programme operations, show the conditions of the operating unit at any time and change the operating parameters.

The functions of the 6 buttons of the pCO interface are listed in the following table:

Icon	Key	Description
	<b>ALARM</b>	Press the <b>ALARM</b> key to access the alarm list. The button lights up when an alarm is triggered.
	<b>PROGRAM</b>	Press the <b>PRG</b> key to access the main menu or to edit a parameter.
	<b>ESC</b>	Press <b>ESC</b> to move up to a higher level in the menu.
	<b>UP</b>	Press <b>UP</b> to go to the next screen or increase the value of a parameter.
	<b>ENTER</b>	Press <b>ENTER</b> to access a parameter to be edited, to confirm editing of a parameter or to select a menu item.
	<b>DOWN</b>	Press <b>DOWN</b> to go to the previous screen or decrease the value of a parameter.

## 10 START-UP

### 10.1 Preliminary checks

- Check that all the valves in the cooling circuit are open.
- Check that the electrical connections have been made properly and that all the terminals are securely tightened. This check should also be included in a periodic six-month inspection.
- Check that the voltage at the LN terminals is  $230V \pm 10\%$  (in the case of single-phase power supply) or RST terminals is  $400 V \pm 5\%$  (in the case of three-phase power supply) and make sure the yellow indicator light of the phase sequence relay is on. The phase sequence relay is present only in units with three-phase power supply; if the sequence is not duly observed, it will not enable the machine to start.
- Make sure that there are no refrigerant leaks due to accidental impacts during transport and/or installation.
- Check that the water connections have been properly made according to the indications given on the plates located on the unit itself and the dimensional drawings enclosed with the unit's documentation.
- Make sure that the water circuit is duly bled to completely eliminate the presence of air: fill the circuit gradually and open the air vent valves on the top part, which the installer should have set in place.
- Check the power supply to the crankcase heating elements, where present. To ensure the correct operation of the heating elements, check that the lower part of the compressors is hot and in any case, that it is at a temperature 10 - 15°C higher than ambient temperature.

#### Hydraulic connections

##### **ATTENTION**

The chiller is charged with HFC R410A or R454B – Group II EN 378 refrigerant (non-hazardous substances) conforming to the requirements of EEC regulation 2037/00.

- The heat pumps are intended to be integrated into systems, even complex ones, that employ water as a heat transfer fluid. Although all the components used in the hydraulic circuits are designed for this purpose by using suitable materials, we recommend checking the quality of the water used to fill and top up the system, as indicated in paragraph "8.2.1 Filling of the plants p. 29", to ensure constant performance of the unit over time and avoid unpleasant failures.
- Water connections must be carried out respecting the inlets and outlets as marked on the connections and on the enclosed documentation. Take great care not to reverse the circuits;
- Provide cut-off valves on the water side to be able to intercept the unit respect to the system;
- Load the water circuits and make sure you bleed out all the air inside them via the vents located on the highest points of the pipes and at the top of the tank, if there is one.

#### Electrical connections

##### **ATTENTION**

The unit is not equipped with magneto-thermal protection. Provide for suitable protections before connecting the unit to the mains.

- Remove the front panel to access the electric panel;
- Insert the power cable through one of the knockouts placed in the side panels or in the rear;
- Connect the power supply and earthing wire to the terminals;
- Power on the equipment via the arranged main switch;
- Activate the automatic switch inside the electrical panel

#### Start-up

- Check that all valves of the water circuits are open and water flows properly (the flow alarm should not be triggered);
- Put the main switch on the ON position;
- The unit is now in standby mode; start it as indicated in the manual;
- Check the temperature difference at water level (12-7 °C on the user side in typical summer operation, to be checked with a thermometer on the water inlet and outlet pipes from the unit);
- Check the water circuits for leaks;
- Turn off the unit.

#### Use

##### **ATTENTION**

Consult the manuals supplied for all maintenance and/or advanced set-up operations.

##### **WARNING**

The commissioning of the unit must comply with the statutory regulations of the State where the machine is installed. The responsibility for correct use is exclusively ascribable to the user.

### 10.2 Start-up the unit

Ad for the commands mask, there can be different configurations based on the type of unit or the settings of the final user. The following table shows the various icons that may be featured, with their relative meaning.

Pos.	Icon	Description
1.		Main ON-OFF of the unit.
2.		Access to information menu (work sizes, device status, software version).
3.		Selection of utility cold/hot mode (summer/winter).
4.		Adjustment of set-points of all utilities (air conditioning/DHW).
5.		Adjustment of air conditioning system set-point.
6.		Access to advanced user / maintenance / manufacturer parameters menu.
7.		DHW set-point adjustment.

### Switching on from local or remote display

To switch the unit on from the local/remote display, enter the command screen and select the **START** command then press **ENTER** to access the switch-on mask:

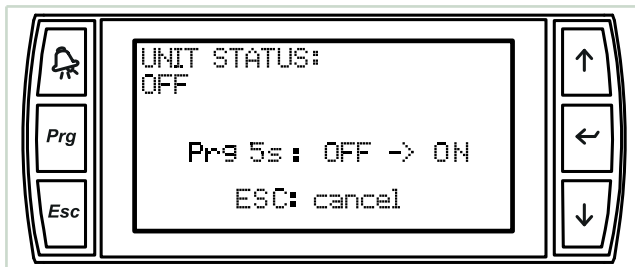

Press the key **PRG** for 5 seconds to switch the status of the machine or press the key **ESC** to exit without changing the status.

The group will start if an enabling signal is received:

- linked to safety devices related to the water circulation pump(s);
- the flow switch (or differential pressure switch);
- of the plant backflow water temperature sensor (chiller inlet);
- there are no triggered alarms; if there are, clear the alarm to be able to start-up the unit.

**WARNING**

If the unit fails to start up, check whether the service thermostat has been set at the rated calibration values.

### Switching On from digital input

If remote ON-OFF has been enabled from the digital input, the input must be closed (with inverse logic) so that the unit can start (open with direct logic). Refer to the wiring diagram enclosed with the unit to correctly identify the terminals designed for the ON-OFF functions from the digital input.

**ATTENTION**

The remote ON/OFF terminals are normally bridged. In this case if you wish to use this function, remove the bridge and place a potential-free contact. The contact draws the 24Vac voltage directly from the unit. The digital input must be configured correctly.

### 10.2.3 Switching On from supervisor

If ON-OFF from the supervisor is among the options selected, then the communication port BMS must be configured and the following values must be written on the variable:

- **0** = unit OFF
- **1** = unit ON

See the list of supervision variables featured in the documentation enclosed with the unit for the address of the specific variable.

**ATTENTION**

Before switching ON-OFF from the supervisor, make sure that the communication port has been configured properly, that the bus is wired correctly and with a suitable cable, and that the communication protocols are compatible.

### 10.2.4 Switching On from the LAN network Master

If the unit is inserted in a LAN network between units, the start consent is determined by the Master logics and the final user cannot force starting. In this case the user can only switch the unit off, using the main switch on the local display.

**ATTENTION**

You should not disconnect the unit from the power supply during periods when it is idle but only when it is to be taken out of service for a prolonged period (e.g. at the end of the season).

**WARNING**

If one or several options among the ones listed in this paragraph have been activated, all the selected sources must provide their consent to switch on the unit.

## 10.3 Selecting the operating modes

The active mode of the utility is indicated in the status bar on the main mask.

The following table summarises the possible indications:

Pos.	Icon	Description
1.		Summer mode active.
2.		Winter mode active.
3.		Disabled utility

In the "DISABLED UTILITY" mode, the unit only produces heat for Domestic Hot Water.

In this case, in the absence of a DHW call, the unit remains on standby.

For cooling/heating reversible units, the software offers various ways of selecting the mode, namely:

1. Select from local display
2. Select from remote display
3. Select from digital input
4. Select from supervisor

**WARNING**

To avoid incompatible mode choices, only one option can be selected.

**WARNING**

The "UTILITY DISABLED" function (OFF option from the display) can only be selected from the remote or local display.

### Selection from the local or remote display

To select the mode from the local display, select the command from the command panel and press **ENTER** to access the setting mask of the operating mode.

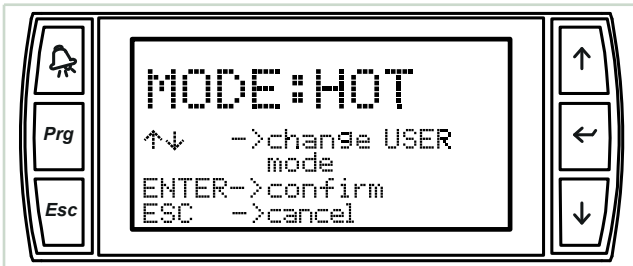

Use the **UP** or **DOWN** keys to select the new status; press **ENTER** to confirm the new status or press **ESC** to exit without changing the status.

The selection from the local or remote display allows you also to choose the **OFF** mode, namely to disable the utility. In this case if the unit is multi-purpose, it will only start for domestic hot water production.

### Select from digital input

If the selection has been enabled from the digital input, the input must be closed (with inverse logic) so that the unit can be in summer mode (open with direct logic).

In summer mode, the unit sets up to produce cold water, in winter mode, hot water.

**WARNING**

Refer to the wiring diagram enclosed with the unit to correctly identify the terminals designed for switching from summer to winter mode and vice versa from the digital input.

**ATTENTION**

The terminals for mode selection are normally bridged. In this case if you wish to use this function, remove the bridge and place a potential-free contact. The contact draws the 24Vac voltage directly from the unit. The digital input must be configured correctly.

### Select from supervisor

If the mode has been selected from the supervisor, then the communication port BMS must be configured and the following values written on the variable:

- 0 = summer mode
- 1 = winter mode

**WARNING**

See the list of supervision variables featured in the documentation enclosed with the unit for the address of the specific variable.

**ATTENTION**

Before using the mode, make sure that the communication port has been configured properly, that the bus is wired correctly and with a suitable cable, and that the communication protocols are compatible.

## 10.4 Setting the set-points

To modify the operating set-point, select one of the following icons from the command menu based on the active configurations and press **ENTER**:

Pos.	Icon	Description
1.		To change the air-conditioning utility set-point
2.		To change the domestic hot water set-point (DHW)
3.		To change utility and DHW set-points

Once you have entered the setting template:

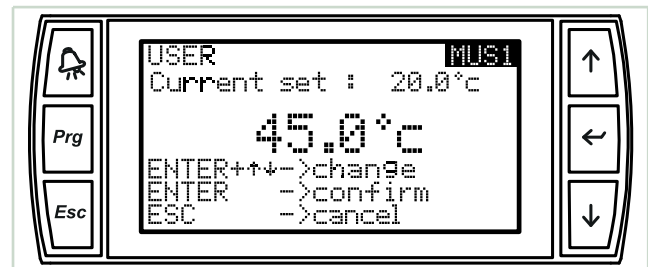

1. Use the **UP** key to increase the set-point;
2. Use the **DOWN** to decrease the set-point;
3. Press **ENTER** to confirm the new value;
4. Press **ESC** to quit without changing the set-point.

**WARNING**

For supplementary functions to be applied to the set-point, see the specific paragraph of the microprocessor enclosed with the unit's documentation.

## 10.5 Checks during operation

- Check the relay on the control board to verify whether the phases occur in the correct sequence: if they do not, disconnect the unit from power supply and reverse two phases of the three-core cable at the unit input. Never attempt to modify internal electrical connections: any undue modifications will render the warranty null and void.
- Check that the temperature of the water entering the evaporator is close to the value set on the service thermostat.

- After a few hours of operation, check whether the liquid level indicator has a green crown: a yellow colour indicates the presence of humidity in the circuit. In such a case the circuit must be dehumidified by qualified personnel.
- Large quantities of bubbles should not appear through the liquid level indicator. A constant passage of numerous bubbles may indicate that the refrigerant level is low and needs to be topped up. The presence of a few bubbles is however allowed, especially in the case of high-glide ternary mixtures such as HFC R410A or R454B.
- Also check that the end-of-evaporation temperature shown on the pressure gauge (refer to the pressure gauge scale for the refrigerant R410A or R454B) is about 4°C lower than the temperature of the water leaving the evaporator.

Make sure the overheating of the cooling fluid is limited to between 5 and 8 °C. To this end:

1. detect the temperature indicated by a contact thermometer placed on the compressor intake pipe;
2. read the temperature indicated on the scale of a pressure gauge likewise connected to the intake side; refer to the pressure gauge scale for the refrigerant R410A or R454B.

The degree of superheating is given by the difference between the temperatures thus determined.

Make sure that the undercooling of the cooling fluid is limited to between 3 and 5°C. To this end:

1. detect the temperature indicated by a contact thermometer placed on the compressor outlet pipe;
2. read the temperature indicated on the scale of a pressure gauge connected to the liquid inlet at the condenser outlet; refer to the pressure gauge scale for the refrigerant R410A or R454B.

The difference between the temperatures determined in this way indicates the undercooling value.

 **ATTENTION**

All models are filled with R410A or R454B refrigerant.

Eventual top-ups must be done with the same type of refrigerant and are part of the routine maintenance operations performed by qualified personnel.

 **ATTENTION**

The refrigerant R410A or R454B requires “POE” polyolester oil of the type and viscosity indicated on the compressor rating plate.

For no reason should oil of a different type be introduced into the oil circuit.

## 10.6 Stopping the unit

The unit can be stopped by pressing the “OFF” control on the front panel of the display on the switch-on mask.

 **ATTENTION**

To stop the unit do not disconnect it using the main switch: this device must only be used to disconnect the unit from the power supply without current flow, i.e. when the unit is switched **OFF**.

## 11 ROUTINE MAINTENANCE AND CHECKS

### ATTENTION

The only tasks to be performed by the end user are turning the chillers on and off and switching them between the cooling and heating functions as the seasons change.

All other operations are maintenance tasks and must be performed by qualified personnel who are able to operate according to the laws and regulations in force.

### 11.1 Warnings

#### ATTENTION

All the operations described in this chapter **MUST ALWAYS BE PERFORMED BY QUALIFIED PERSONNEL**.

#### WARNING

Before carrying out any work on the unit or accessing internal parts, make sure you have disconnected it from the mains power supply.

### ATTENTION

After completing maintenance jobs, always replace the panels enclosing the units and secure them with the fastening screws provided.

#### WARNING

The top part and the supply piping of the compressor are at high temperatures. Be especially careful when working close by with open panelling.

### 11.2 Maintenance table

To make sure performance remains constant in time, it is recommended to respect the following maintenance and control schedule in addition to what is required by the regulations in force.

Activity	Frequency
Check the efficiency of all the control and safety devices.	Yearly
Check the terminals on the electric control board and compressor terminal boards to ensure that they are securely tightened. The movable and fixed contacts of the contactors must be periodically cleaned and replaced whenever they show signs of deterioration.	Yearly
Check the refrigerant level by means of the liquid level indicator.	Yearly
Check the oil levels through the indicators provided on the compressor crankcases.	Yearly
Check the water circuit for leaks.	Every 6 months
If the unit is to remain inactive for a long period of time, discharge the water from the piping and from the heat exchanger. This operation is of the utmost importance especially when there are periods while the unit is idle in which the temperature drops below the freezing point of the fluids used.	Yearly
Check that the water circuit is full.	Every 6 months
Check the efficient operation of the flow switch or differential pressure switch.	Yearly
Clean the external metal filters in the hydraulic lines.	Every 6 months
Check the humidity indicator (green=dry, yellow=humid) on the liquid level indicator; if the indicator is not green as shown on the indicator sticker, replace the filter.	Yearly

As required by Regulation (EU) no. 517/2014, the operators of equipment for which leakage checks are necessary (load of fluorinated gases equal to or greater than 5 tons of CO<sub>2</sub> or 10 tons of CO<sub>2</sub> equivalent if "hermetically sealed equipment"), must communicate electronically all the information relating to the activities control of leaks as well as installation, assistance, maintenance, repair, dismantling activities to the National Database;

In particular:

- Quantity and type of refrigerant installed;
- the quantities of fluorinated gases added during the installation, maintenance or assistance or due to leaks
- the quantities of installed fluorinated gases that have been recycled or regenerated, including the name and address of the plant recycling or reclamation and, where applicable, the certificate number;
- the quantities of fluorinated greenhouse gases recovered;

- the dates and results of the leak checks and the cause of any losses found;
- if the equipment has been dismantled, the measures taken to recover and dispose of fluorinated effect gases greenhouse;
- dates and results of checks on the detection system leaks (if installed).

It is normally the responsibility of the owner of the equipment arrange for the checks to be carried out by authorized operators leak research periodicals according to the reported frequency in the table:



EQUIPMENT NOT HERMETICALLY SEALED		HERMETICALLY SEALED EQUIPMENT	
Teq CO <sub>2</sub>	Periodic check	Teq CO <sub>2</sub>	Periodic check
≥ 5 : < 50	12 months	≥ 10 : < 50	12 months
≥ 50 : < 500	6 months	≥ 50 : < 500	6 months
≥ 500	3 months	≥ 500	3 months

For the CO<sub>2</sub> Teqs contained in the equipment, refer to the identification label supplied with it.

 **WARNING**

In Italy the booklet is regulated by the D.P.R. 146/2018.

### 11.3 Refrigeration circuit repairs

 **ATTENTION**

While performing repairs on the cooling circuit or maintenance work on the compressors, make sure the circuit is left open for as little time as possible. Even if briefly exposed to air, ester oils tend to absorb large amounts of humidity, which results in the formation of weak acids.

If the refrigeration circuit has been repaired, the following operations must be carried out:

- leak test;
- refrigeration circuit vacuum and drying cycle;
- refrigerant charge

 **WARNING**

If the system has to be drained, always recover the refrigerant present in the circuit using suitable equipment; the refrigerant should be handled exclusively in the liquid phase.

### 11.4 Tightness test

Fill the circuit with anhydrous nitrogen supplied from a tank with a pressure-reducing valve until the pressure rises to 10 bar.

 **ATTENTION**

During the pressurisation phase, do not exceed the pressure setting of the safety valves; otherwise you will cause the latter to open.

The presence of any leaks must be determined using special leak detectors. Should any leaks be detected during the test, empty out the circuit before repairing the leaks with suitable alloys.

 **DANGER**

Do not use oxygen in the place of nitrogen as a test agent, since this could cause a risk of explosion as well as the certainty of extensive oxidation in high-temperature areas.

### 11.5 High vacuum and refrigeration circuit drying

To achieve a hard vacuum in the cooling circuit it is necessary to use a pump capable of generating a high degree of vacuum, i.e. 15 Pa of absolute pressure with a capacity of approximately 10 m<sup>3</sup>/h. If such a pump is available, one evacuation will normally suffice to achieve an absolute pressure of 15 Pa. If there is no such vacuum pump available, or whenever the circuit has remained open for long periods of time, you are strongly recommended to adopt the triple evacuation method. This method is also recommended when there is a presence of humidity within the circuit.

The vacuum pump should be connected to the inlets. The required procedure is as follows:

- Drain the circuit to an at least 35 Pa absolute pressure: at this point, introduce nitrogen in the circuit up to a pressure of about 1 bar.
- Repeat the operation described in the point here above.
- Repeat the operation described in the point here above for the third time, now trying to achieve the hardest possible vacuum condition.



With this procedure it is possible to easily remove up to 99% of the pollutants.



## 12 TROUBLESHOOTING

### 12.1 Unit alarm

**ATTENTION**

If an alarm is triggered and the **ALARM** button  lights up, do not press the **ALARM** button  to reset the alarm and immediately contact our After Sales Service. For the full list of alarms, refer to the documentation enclosed with the unit.

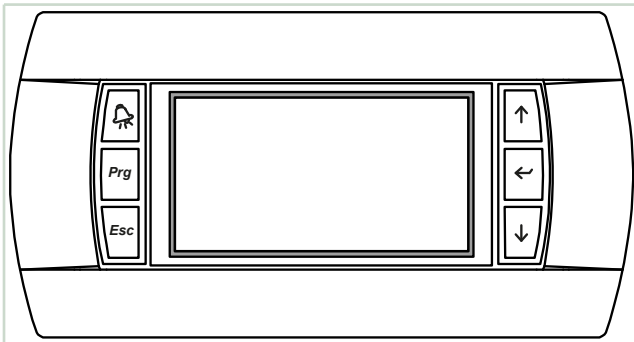

### 12.2 Troubleshooting

For troubleshooting purposes, please refer to the list and to the complete description of the alarms related to the installed software version.

This document can be downloaded from the portal <https://obdoc.gallettigroup.com> after user registration.

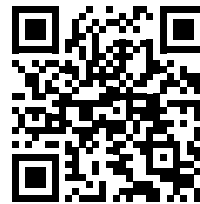

**ATTENTION**

Do not reset the alarm until after an accurate analysis and subsequent removal of the causes of the alarm: continuous resetting operations could lead to compressor breakdowns.

**DANGER**

As far as possible remedies are concerned, it is first of all essential to have read the chapter "3 General description p. 7" and the chapter "4.2 Safety prescriptions p. 11", to be able to adopt all the necessary precautions.

**WARNING**

You should be extremely careful when attempting to implement any of the possible remedies suggested: overconfidence can result in injuries, even serious ones, to inexperienced individuals.

In case of breakdowns, please contact a qualified and authorised technician or our customer care.

## Customer Service



049-9271513



support@eneren.it

## 13 SAFETY DATA SHEET OF REFRIGERANT

For refrigerant fluid safety data sheet, please refer to the documents supplied with the unit.

## 14 MAINTENANCE TABLE

Fill in the following table to keep the track of the maintenance carried out:

FIRST START-UP DATE ___/___/_____	YEAR											
	SEMESTER		1°	2°	1°	2°	1°	2°	1°	2°	1°	2°
Check the efficiency of all the control and safety devices.												
Check the terminals on the electric control board and compressor terminal boards to ensure that they are securely tightened. The movable and fixed contacts of the contactors must be periodically cleaned and replaced whenever they show signs of deterioration.												
Check the refrigerant level by means of the liquid level indicator.												
Check the oil levels through the indicators provided on the compressor crankcases.												
Check the water circuit for leaks.												
If the unit is to remain inactive for a long period of time, discharge the water from the piping and from the heat exchanger. This operation is of the utmost importance especially when there are periods while the unit is idle in which the temperature drops below the freezing point of the fluids used.												
Check that the water circuit is full.												
Check the efficient operation of the flow switch or differential pressure switch.												
Clean the metal filters.												
Check the humidity indicator (green=dry, yellow=humid) on the liquid level indicator; if the indicator is not green as shown on the indicator sticker, replace the filter.												

## 15 SYSTEM DIAGRAMS

Hydraulic connection diagram for heating, cooling and production of domestic hot water with a multisource aérothermal / geothermal heat pump.

 **ATTENTION**

For proper installation guidelines, please follow the dimensional and wiring diagrams supplied with the unit.

 **ATTENTION**

The system diagrams shown in this manual are generic and illustrative. For proper installation guidelines, please follow the dimensional and wiring diagrams supplied with the unit.

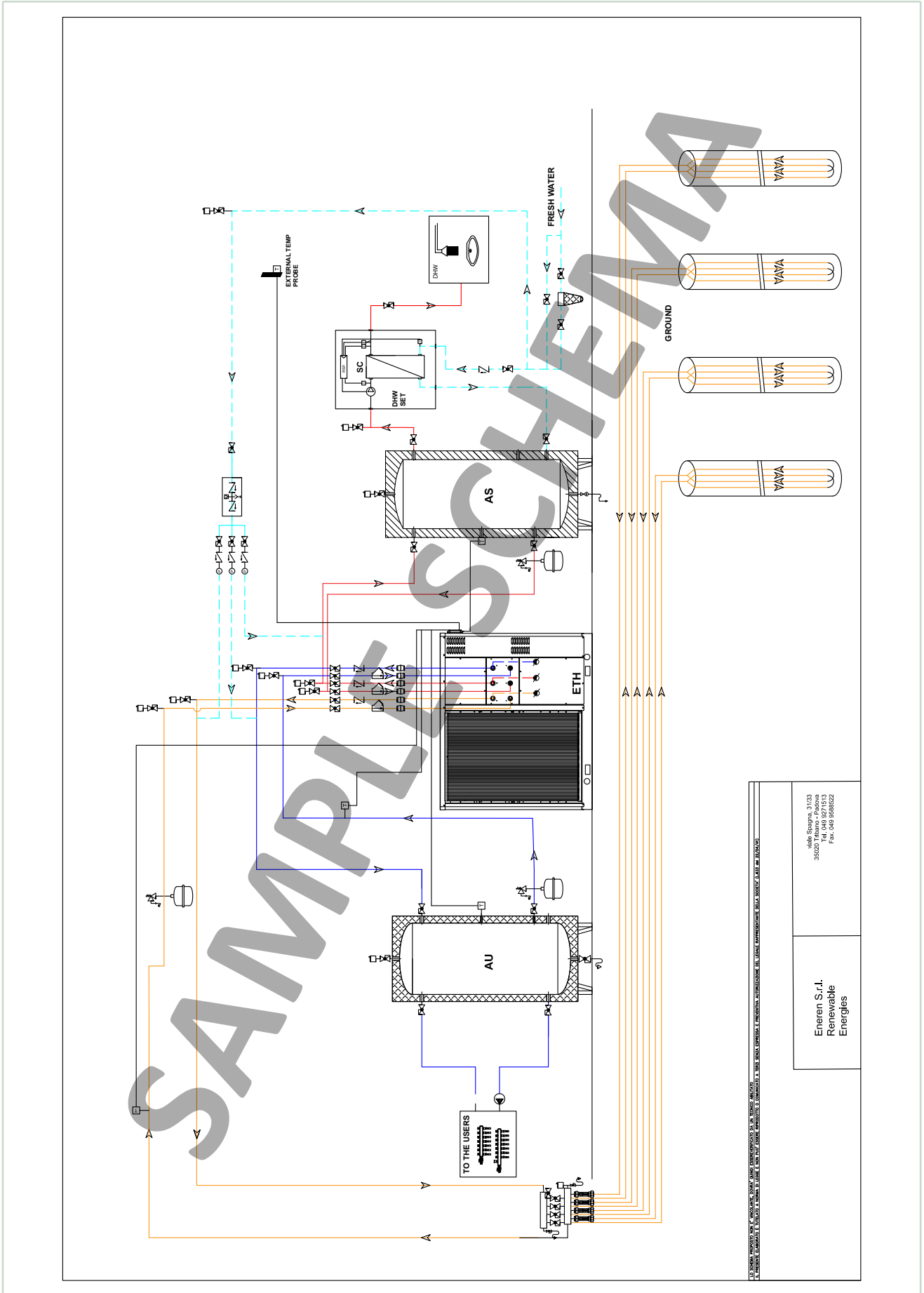

viale Spinaia, 3153  
35020 Montebelluna (TV)  
Tel. 0423 927151/9  
Fax. 0423 956852/2

Eneren S.r.l.  
Renewable  
Energies

LA PRESSIONE TERMICA DEL FLUIDO SOLARE E' SUPERIORE A QUELLA DEL FLUIDO CIRCULANTE NELLA TUBERIAZIONE. IL FLUIDO SOLARE SI RISCALDA PER CONDUZIONE E PER CONVESSIONE. IL FLUIDO CIRCULANTE SI RISCALDA PER CONDUZIONE E PER CONVESSIONE. IL FLUIDO CIRCULANTE SI RISCALDA PER CONDUZIONE E PER CONVESSIONE. IL FLUIDO CIRCULANTE SI RISCALDA PER CONDUZIONE E PER CONVESSIONE.

**16 NOTES**

-----

-----

-----

-----

-----

-----

-----

-----

-----

-----

-----

-----

-----

-----

-----

-----

-----

-----

-----

-----

-----

-----

-----

-----

-----

-----

-----

-----

-----

-----

-----

-----

-----

-----

-----

-----

-----

-----

-----

-----

-----

-----

-----

-----

-----

-----

-----

-----

If any usage other than those described in this User Manual is envisaged, the user must contact ENEREN and, before using, expressly request the written authorization from ENEREN. Otherwise, the usage is exclusively at the user's risk.

In these cases, the usage, use and processing of our products are beyond our control.

If, despite everything, a dispute should arise on our responsibility, this will be limited to the value of the products supplied by us and used by you. Rights derived from warranty statements are no longer valid in the event of applications not described in the Technical information.

This document is copyrighted. In particular, the translation, reprinting, excerpt of individual images, transmission over the air, any type of reproduction using photomechanical or similar devices, as well as computer archiving without our explicit authorization is prohibited.



Viale Spagna, 31/33 - 35020 Tribano (Padova) - Italy  
Ph. +39 049 9588511 - Fax: +39 049 9588522 - info@eneren.it  
www.eneren.it